



Society of Antiquaries
of **Scotland**

SCOTTISH ARCHAEOLOGICAL INTERNET REPORTS

e-ISSN: 2056-7421

Fluid identities, shifting sands: Early Bronze Age burials at Cnip Headland, Isle of Lewis

How to cite:

Lelong, O 2018 'Fluid identities, shifting sands: Early Bronze Age burials at Cnip Headland, Isle of Lewis', *Scottish Archaeological Internet Reports* 75.
<https://doi.org/10.9750/issn.2056-7421.2018.75>

Visit <http://journals.socantscot.org/index.php/sair> to see the journal homepage

OPEN  ACCESS

Please note:

This document is the publisher's PDF of an article published in the Scottish Archaeological Internet Reports journal. This version has been peer-reviewed and contains all final editorial corrections and journal pagination.

Copyright © 2018 rests with the Society and the individual authors. Except where otherwise noted, this work is licensed under Creative Commons Attribution-NonCommercial-No Derivatives licence.
<http://creativecommons.org/licenses/by-nc-nd/4.0/>

The permission to reproduce the Society's copyright-protected material does not extend to any material which is identified as being the copyright of a third party. Authorisation to reproduce such material must be obtained from the copyright holders concerned.



Fluid identities, shifting sands: Early Bronze Age burials at Cnip Headland, Isle of Lewis

Olivia Lelong

with contributions by

Thomas Booth, Jane Evans, Derek Hamilton, Brendan J Keely, Maureen Kilpatrick, Susanna Kirk, Angela Lamb, Dawn McLaren, Susan Ramsay and Alison Sheridan

Illustrations by

Ingrid Shearer and Marion O'Neil

Address

Northlight Heritage, South Block, 64 Osborne Street, Glasgow G1 5QH

Author contact

olelong@yorkat.co.uk

Funding

Historic Environment Scotland



e-ISSN: 2056-7421

<https://doi.org/10.9750/issn.2056-7421.2018.75>

Published by the Society of Antiquaries of Scotland with the Archaeology Data Service archaeologydataservice.ac.uk.

Society of Antiquaries of Scotland
National Museums Scotland
Chambers Street
Edinburgh EH1 1JF
United Kingdom

Managing editor: Catherine Aitken
Copy-editor: Susan Milligan
Production: Raspberry Creative Type, Edinburgh

Copyright © 2018 rests with the Society and the individual authors. Except where otherwise noted, this work is licensed under Creative Commons Attribution-NonCommercial-NoDerivatives licence. <http://creativecommons.org/licenses/by-nc-nd/4.0/>

Requests for permission to reproduce material from a SAIR report should be sent to the Director of the Society of Antiquaries of Scotland, as well as to the author, illustrator, photographer or other copyright holder.

www.socantscot.org

Registered Scottish charity no SC010440

TABLE OF CONTENTS

List of illustrations	iv
List of tables	v
1.a Geàrr-chunntas	1
1.b Abstract	1
2. Introduction	1
3. Archaeological context	5
4. Excavation of the burials	6
4.1 Area A	6
4.2 Area C	9
4.3 Area D	14
5. The human remains	16
5.1 Skeletal analysis <i>by Maureen Kilpatrick</i>	16
5.2 Stable isotope analysis of the human remains <i>by Jane Evans & Angela Lamb</i>	23
5.3 Radiocarbon dates and Bayesian analysis <i>by Derek Hamilton</i>	29
6. Artefacts with the burials	36
6.1 Worked bone in Area A <i>by Dawn McLaren</i>	36
6.2 Artefacts with the human remains in Area C <i>by Alison Sheridan</i>	39
7. Macroplant remains <i>by Susan Ramsay</i>	44
8. Analysis of soil organic matter <i>by B J Keely</i>	45
9. Discussion <i>by Olivia Lelong</i>	53
9.1 Interpreting the sequence of events	53
9.2 Burial practices on Cnip Headland	59
9.3 Fluid identities	60
10. Acknowledgements	62
11. References	64

LIST OF ILLUSTRATIONS

1. Location map	2
2. The deflation hollow from the north during the January 2009 excavation	3
3. Plan of the deflation hollow, showing the locations of the excavation areas, the cairn and the previously excavated Early Bronze Age and Viking burials	4
4. Plan of the stone-lined grave in Area A, showing the partly displaced covering slabs	6
5. Plan of the burial in Area A	7
6. Section through the grave in Area A	8
7. Section through the kerbed mound in Area C showing its make-up, and a view of the burials from the north-west after the excavation of Cluster 1	10
8. Post-excavation plan and photograph of the kerbed mound	11
9. Plan of the human remains in Area C	12
10. Clusters 2 and 3 in Area C, with bones shaded according to age	13
11. Profile across the Early Bronze Age cairn and Area D	14
12. Plan of the infant burial in Area D	15
13. South-east facing section through the Area D burials	16
14. Plan of the adult burial in Area D	17
15. Comparison of sulphur data for burials at Cnip Headland with other UK archaeological data	25
16. Periosteal surface of an Sk 2 femoral thin section	28
17. Periosteal surface of the Sk1 left femoral thin section	29
18. Chronological model for the Bronze Age burials at Cnip Headland	32
19. Plot of the stable isotope results for those human bone samples where there is both a $\delta^{13}\text{C}$ and $\delta^{15}\text{N}$ measurement available	33
20. Span of activity associated with the radiocarbon dates from Cnip Headland	35
21. Worked bone/ivory from Area A	37
22. The copper alloy awl and jet beads from Area C	40
23. Photographs of the fusiform jet bead SF15	41
24. Photographs of the chunky jet bead SF23	41
25. Photograph of the sinew in jet bead SF23	43
26. (a) Total organic carbon contents of <200 μm soil fraction, with (b) fatty acid methyl ester (FAME) abundances in Cnip Headland samples plotted by carbon number of the fatty acid	47
27. Alkanol abundances (a) and alkane abundances (b) in Cnip Headland samples plotted by carbon chain length	49
28. Alkane abundances in Cnip Headland Samples 01 and 08 plotted by carbon chain length	50
29. Distribution of TAGs in Samples 07 and 09	51
30. Abundance profiles of amino acids isolated from Cnip Headland soils	54
31. The excavated cairn from the south	55
32. Clusters 2 and 3 in Area C from the south, with the stone-lined grave in Area A in the background	56
33. The burial in Area A, from the east	57
34. The stone-lined grave in Area A, with collapsed capping, from the south	58
35. The Area D burial before excavation	59

LIST OF TABLES

1. Age categories	18
2. Indicators of age in Skeleton 1 from Area A	18
3. Bones from Context 25 (Cluster 1) for which age was observable	21
4. Bones from Context 17 for which age was observable	22
5. Stable isotope data for Skeletons 1 and 2 from Cnip Headland	24
6. Sulphur data for Skeletons 1 and 2 from Cnip Headland	25
7. Oxford Histological Index scores of the Cnip Headland thin sections	27
8. Radiocarbon results from Cnip Headland	30
9. Calibrated dates for radiocarbon results on samples of human bone identified as having a marine component	34
10. Samples analysed and discussed in the organic soils report	45
11. Elemental abundances in <200µm soil fraction from Cnip Headland	46
12. Atomic elemental abundances and elemental ratios in <200µm soil fraction from Cnip Headland	46
13. Percentage TAG composition and total response for Samples 07 and 09	48
14. Bulk percentage fatty acid composition of the TAGs	49
15. Potential precursor TAGs for the TAGs in Samples 07 and 09	51
16. Abundances of amino acids released upon hydrolysis of soil samples from Cnip Headland, normalised to grams of total organic carbon (TOC)	52

1.A. GEÀRR-CHUNNTAS

A' cladhach ann an 2009 agus 2010 air Rubha a' Chnìp ann an Eilean Leòdhais, rinneadh sgrùdadh arc-eòlach air trì tiodhlacaidhean eadar-dhealaichte ann an slochan eu-domhain agus air tom cabhsaireach anns an robh iarmad daonna naoinear, cuid slàn agus cuid nam pìosan. Tha anailis hìosto-eòlach chnàimhean a' comharrachadh gun deach leigeil le na cuirp aca seargadh gus an robh iad gu tur, no gu ìre, nan cnàimhichean, mus deach an tiodhlacadh air an làraich seo, ach a-mhàin aon neach (pàiste a bha marbh ga bhreith). Còmhla ri cuid den iarmad daonna bha grìogagan finiche ath-chaithte, brog de dh' aloidh-copair agus pìosan de thosg tuirc agus ìbhri mara. Bha iad air an tiodhlacadh timcheall air càrn. Dhearbh cladhach a rinneadh na bu tràithe gun deach an càrn a thogail san treas linn BC agus gun deach ath-thogail dà thuras an dèidh sin, le iarmad daonna loisgte agus gun a bhith air a losgadh air a ghabhail a-steach ann. Chaidh tiodhlacadh eile ann an sloc a th'air a linigeadh le clachan a chladhach anns na 1990an. A rèir anailis Bayeseach tha e coltach gun deach a' chiad ath-thogail a dhèanamh air a' chàrn, le iarmad daonna ga chàradh ann, thairis air ùine suas ri 150 bliadhna, eadar 1770 agus 1620 BC. Tha gu robh an rubha air a chleachdadh thairis air iomadh bliadhna airson deas-ghnàthan co-cheangailte ri bàs a' soilleireachadh càirdeasan eadar coimhearsnachdan beò agus an sinnsearachd ann an Tràth Linn an Umha ann an ceann an iar-thuath Alba. Chaidh an obair a dhèanamh dha Alba Aosmhor fo Chùmhnant Cladhach Èiginneach Iarmaid Daonna.

1.B. ABSTRACT

Excavations in 2009 and 2010 on Cnip Headland, Isle of Lewis investigated three different burials in shallow pits and on a kerbed mound, containing the inhumed remains of at least nine individuals in both articulated and disarticulated states. Bone histology analysis indicates that the bodies of all but one (a stillborn infant) were allowed to decay and become partly or wholly skeletonised before being buried at this spot. Worn jet beads, a copper-alloy awl and pieces of boar tusk and marine ivory accompanied some of the remains. The burials lay around a cairn, which previous excavations have shown was built in the 3rd millennium BC and then rebuilt twice, with both cremated and unburnt human remains incorporated in it. Another inhumation burial in a stone-lined pit close to the cairn was excavated in the 1990s. Bayesian analysis indicates that the cairn's first reconstruction and the placing of human remains around it took place over a period of up to 150 years between 1770 and 1620 BC. The headland's long use for rites involving human remains illuminates relationships between living communities and their lineages in Early Bronze Age north-west Scotland. The work was carried out for Historic Environment Scotland under the Human Remains Call-off Contract.

2. INTRODUCTION

On a hillock overlooking the broad sweep of beach known as Tràigh na Beirigh on the Isle of Lewis, a cairn built during the 3rd millennium BC became a focal point for activity that included burial in the millennium that followed.

Four inhumed clusters of at least ten individuals have so far been found around this cairn: two clusters in stone-lined pits, one in an unlined pit and one cluster on a kerbed mound. On three occasions, the inhumed and cremated remains of at least three people were also placed in the cairn. The results of excavation of the cairn and one burial have been published previously (Close-Brooks 1995 and Dunwell et al 1995a, respectively). This article reports on the discovery and analysis of the three other clusters of human remains around the cairn, which were exposed by erosion and excavated in January 2009 and 2010, and draws the evidence together to consider the burial practices in their chronological and geographical context.

The burials lay in a large deflation hollow at NGR NB 0998 3656, on a headland to the east of the crofting township of Cnip, at 16m above OD (Illus 1 & 2). The headland extends from the west coast of Lewis into the mouth of Loch Ròg, on the edge of the Bhaltois peninsula. The local landscape consists of undulating dunes and machair (turf-covered

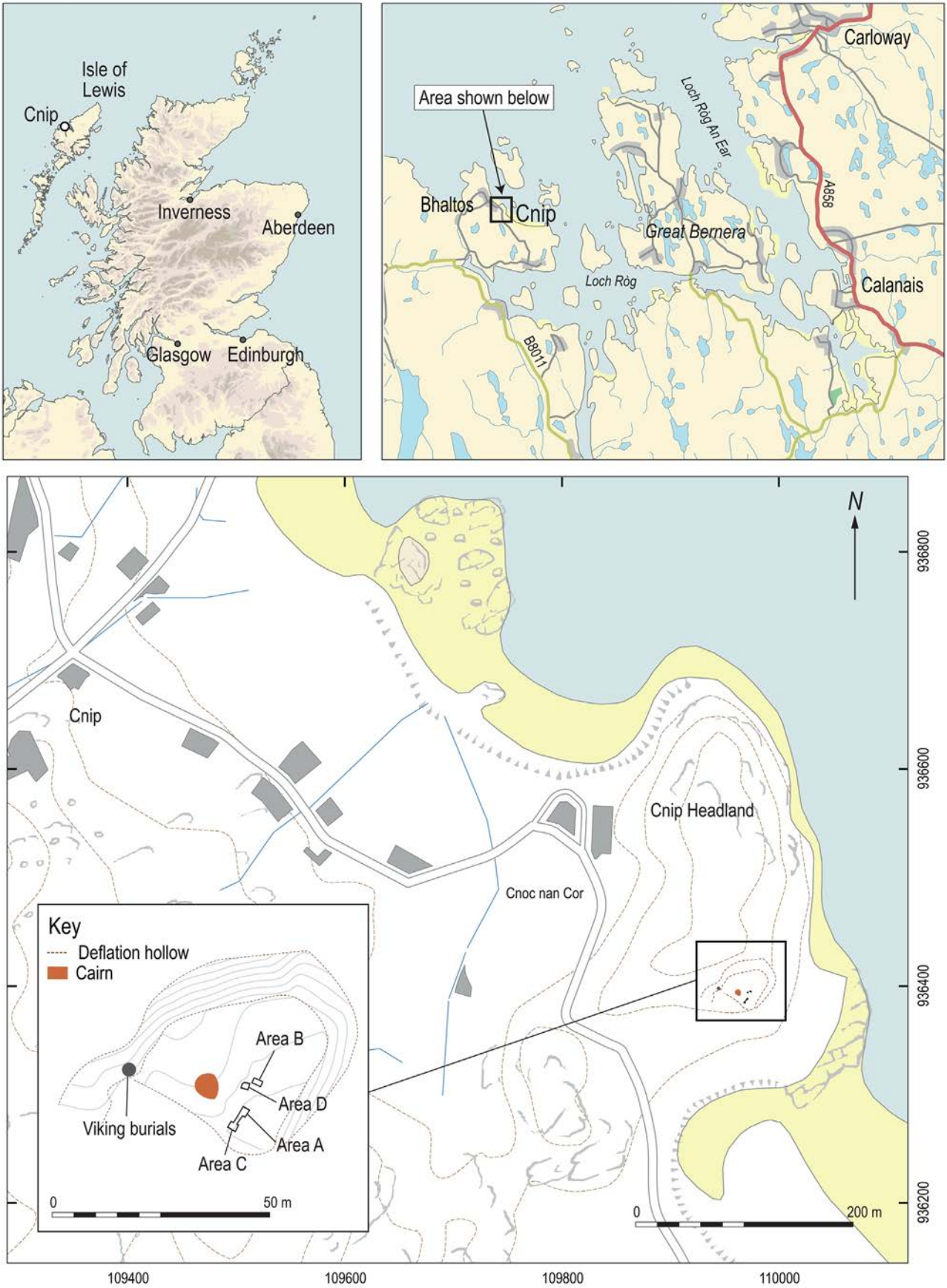

Illus 1 Location map



Illus 2 The deflation hollow from the north during the January 2009 excavation

shell sand) slopes, with some areas of outcropping bedrock. Where the turf has been breached, wind blows out the sand, creating deflation hollows such as this one in the machair. Across the eastern and northern parts of the hollow are expanses of mid-brown sand littered with marine shells, but elsewhere the wind has scoured away old ground surfaces. The sides of the hollow rise steeply to the surrounding machair and bedrock outcrops at its western edge. From its southern lip, the ground descends steeply to the sea. The solid geology consists of bedrock of the Uig Hills–Harris Igneous Complex to the west and Scourian Gneisses to the east.

In December 2008 and again in January 2010 human bone was observed on the deflated surface and reported to the Western Isles Council Archaeologist (Dr Mary MacLeod on the first occasion and Deborah Anderson on the second), who informed Historic Scotland and the Northern Constabulary in Stornoway. Excavation was carried out in January 2009 by a team from the former

Glasgow University Archaeological Research Division and in January 2010 by Carol Knott of CK Archaeology. The two phases of work were carried out under the Human Remains Call-off Contract issued by Historic Scotland, who funded and monitored the fieldwork and post-excavation work. Illus 3 shows the locations of the excavated areas.

In January 2009 two burial sites were excavated under the direction of the principal author (Lelong 2009) (see Illus 3). A stone-lined pit or short cist containing human remains (Area A) was excavated in a trench that measured 1.6m east/west by 1.8m, with an extension to the south measuring 2m north/south by 1m to investigate its relationship to a mound of sand and stone. An adjoining trench measuring 2.5m east/west by 2m was opened over this mound to expose and recover human remains discovered there (Area C). A sub-rectangular arrangement of closely set stones (Area B), 4m to the north of Area A, was also investigated but proved to be of modern construction. In January

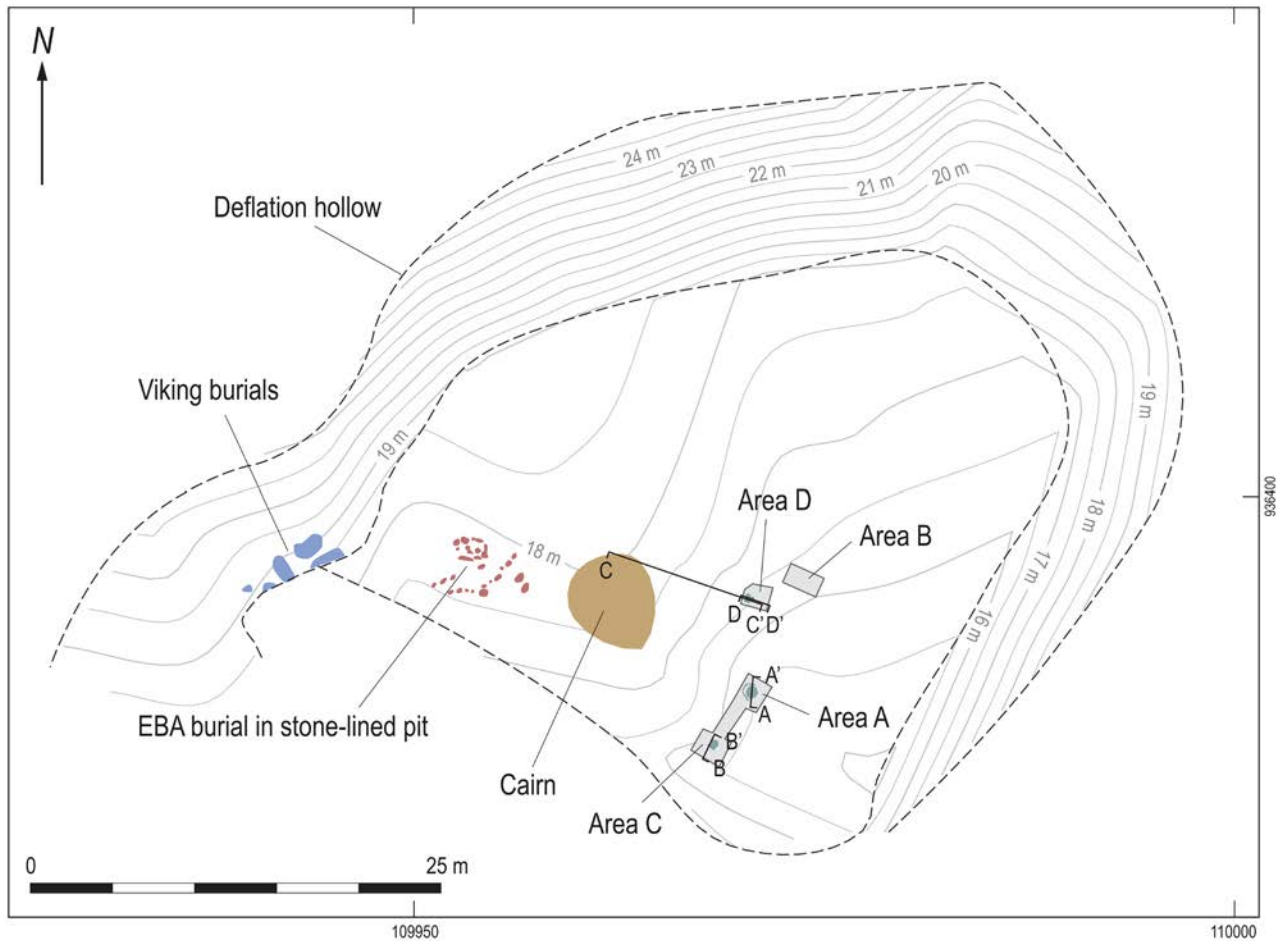

Illus 3 Plan of the deflation hollow, showing the locations of the excavation areas, the cairn (Close-Brooks 1995) and the previously excavated Early Bronze Age and Viking burials (Dunwell et al 1995a; 1995b) (Surveyed January 2009 with additional measurements in January 2010)

2010, another burial site (Area D) was excavated by Carol Knott in a trench measuring 2m north-west/south-east by 1.75m (Knott 2010).

All excavation areas were first recorded by photograph and measured drawing. Loose windblown sand was removed and the positions of disarticulated bone were recorded. In the case of Area A, capping slabs were also removed at this stage. The burials and their matrices were exposed and recorded by photograph and measured drawing, and the human remains were recorded according to standard methodologies for best practice, carefully lifted and bagged according to body part. The positions of all artefacts recovered in the field were recorded in three dimensions.

In Area C, disarticulated bone recovered from the northern edge of the kerbed mound (Context 25) was bagged according to quadrant. For the two clusters of human remains in the centre of the

mound (C17), individual disarticulated bones and groups of articulated or disarticulated bones were assigned small find numbers and their positions were recorded in plan, with levels taken on a representative selection.

Further excavation took place to check for the presence of more human remains beneath the burials, to sample deposits and to establish the sequences for burial and setting construction. In the case of Areas A and D, sections were excavated and recorded across the burial pits. In Area C, the underlying sand was excavated to a depth of 0.1m and then to a further depth of 0.3m across the north-eastern quadrant to establish the mound's sequence of construction, and the east-facing section was recorded. All deposits were sieved on site to recover any small bone fragments or artefacts, and burial matrices were entirely sampled according to body area and retained for analysis. During both phases of

work, spoil was deposited against the eastern edge of the deflation hollow, at least 10m away from known archaeological features.

The programme of post-excavation analysis was designed to maximise information from the human remains, the objects found with them and the burial contexts in order to illuminate the burial rites and the local environment. Study of the human remains included osteological, stable isotope and bone histology analyses to establish the minimum number of individuals represented and evidence for their sex, age at death, pathology and other characteristics, their geographical origins and how the bodies were treated after death. DNA analysis of the human remains was also considered, but did not prove possible within the time constraints of the post-excavation programme. Bulk soil samples were wet-sieved to retrieve carbonised plant remains that would provide evidence of contemporary land use and material for dating. Sub-samples of the burial matrices were analysed for organic matter that might derive from materials placed with the bodies or from decomposition of the bodies themselves. Artefacts found with the burials were studied to understand their biographies and place them in their chronological and cultural contexts.

In this account, the term ‘burial’ is used to refer to the discrete deposits of human remains that were excavated, with the caveat that these were not necessarily inhumation burials in the modern sense but are the archaeological signatures of rites that involved the post-mortem treatment and ultimately the deposition of human remains.

3. ARCHAEOLOGICAL CONTEXT

Both the immediate vicinity of the excavation site and the wider area around the headland are especially rich in archaeological remains of later prehistoric and early historic date. Within the same deflation hollow, about 5m to the west of the recently excavated stone-lined pit (Area A) and the kerbed mound (Area C), a multi-phase cairn containing both inhumed and cremated human remains was excavated in the late 1970s (Close-Brooks 1995) (Illus 3). One of the phases was dated by radiocarbon to the 19th–16th centuries BC, while the latest, kerbed phase of the cairn may have

been built between about 1450 and 1200 BC by comparison with similar, dated monuments on the mainland (Sheridan 2012b: 180). Another stone setting, containing the inhumation of an adult male, was exposed by deflation and excavated 5m to the north-west of the cairn in 1992 (Illus 3), and it yielded a radiocarbon date with a similar range to that for the dated cairn phase (Dunwell et al 1995a). The only cemetery of Viking date so far discovered in the Western Isles lay at the western edge of the deflation hollow, 25m to the west of the Early Bronze Age features (Illus 3). Six burials of 9th–10th-century date, one of them containing artefacts of Viking origin, were exposed by deflation and subsequently excavated, and a seventh – that of a child – was excavated in a nearby deflation hollow to the north (Dunwell et al 1995b).

Although there are no recorded remains of earlier prehistoric settlement on this part of the Bhaltois peninsula, in other words settlement that might be contemporary with the excavated burials, the area does contain abundant traces of later prehistoric settlement (Armit 1994). At Cnip, about 300 metres to the north-west, rescue excavation of a multi-phase wheelhouse settlement dating to the late Iron Age (Armit 2006) was carried out. In the first century AD, part of the skull of an adult male was placed in a shallow pit in the wheelhouse, probably as a foundation deposit. The man had died between 1768 and 1517 BC (at 95.4% probability, SUERC-24965), and the bone could well have come from a Bronze Age burial that had eroded out on the headland (Armit & Shapland in press).

About 1.5 kilometres to the south and south-east of the headland are the complex roundhouse of Dun Bharabhat (NMRS NB03NE 4), the broch tower and overlying Pictish buildings at Loch na Berie (NMRS NB13NW 3) and another probable wheelhouse (NMRS NB13NW 4), all of which have been partially or wholly excavated (Harding 2000; Harding & Dixon 2000; Harding & Gilmour 2000). Middens and pottery eroding out of dunes on Cnip Headland and along Tràigh na Beirigh also attest to prehistoric and later settlement in this part of Lewis (NMRS NB03NE 6, 14; NB13NW 14, 17, 58.1).

4. EXCAVATION OF THE BURIALS

Excavations in 2009 and 2010 recovered the remains of at least nine people, which were left in different configurations and combinations around the eastern side of the cairn over a period of up to 150 years (see 5.3 ‘Radiocarbon dates and Bayesian analysis’ below). The descriptions of the human remains in this section incorporate some observations made by Maureen Kilpatrick in the field and during post-excavation analysis (see 5.1 ‘Skeletal analysis’ below for the detailed results of osteological analysis).

4.1 Area A

About 6 metres to the south-east of the cairn, a burial lay in a shallow pit (Context 10) cut into the consolidated shell sand of the machair (C19). Seven

slabs (C9) stood upright and closely set against the edges to form an angular arc around three sides (Illus 4 & 5). The slabs were of gneiss, mainly blue-grey to dark-grey, but two were pink and white. There was no trace during excavation of an eastern side to the setting. While it is possible that an eastern side had been entirely eroded away and lost, the area has been regularly monitored since deflation began during the 1990s and it is unlikely that this would not have been observed. Although there were traces of two small burrows on the east, there was no evidence of burrowing inside the stone setting or encroaching on the burial itself.

Pale brown, more humic sand (Context 14) had been packed inside the pit to support the slabs (C13), and in a hollow in this sand lay human remains in a formal arrangement (Illus 5 & 6).

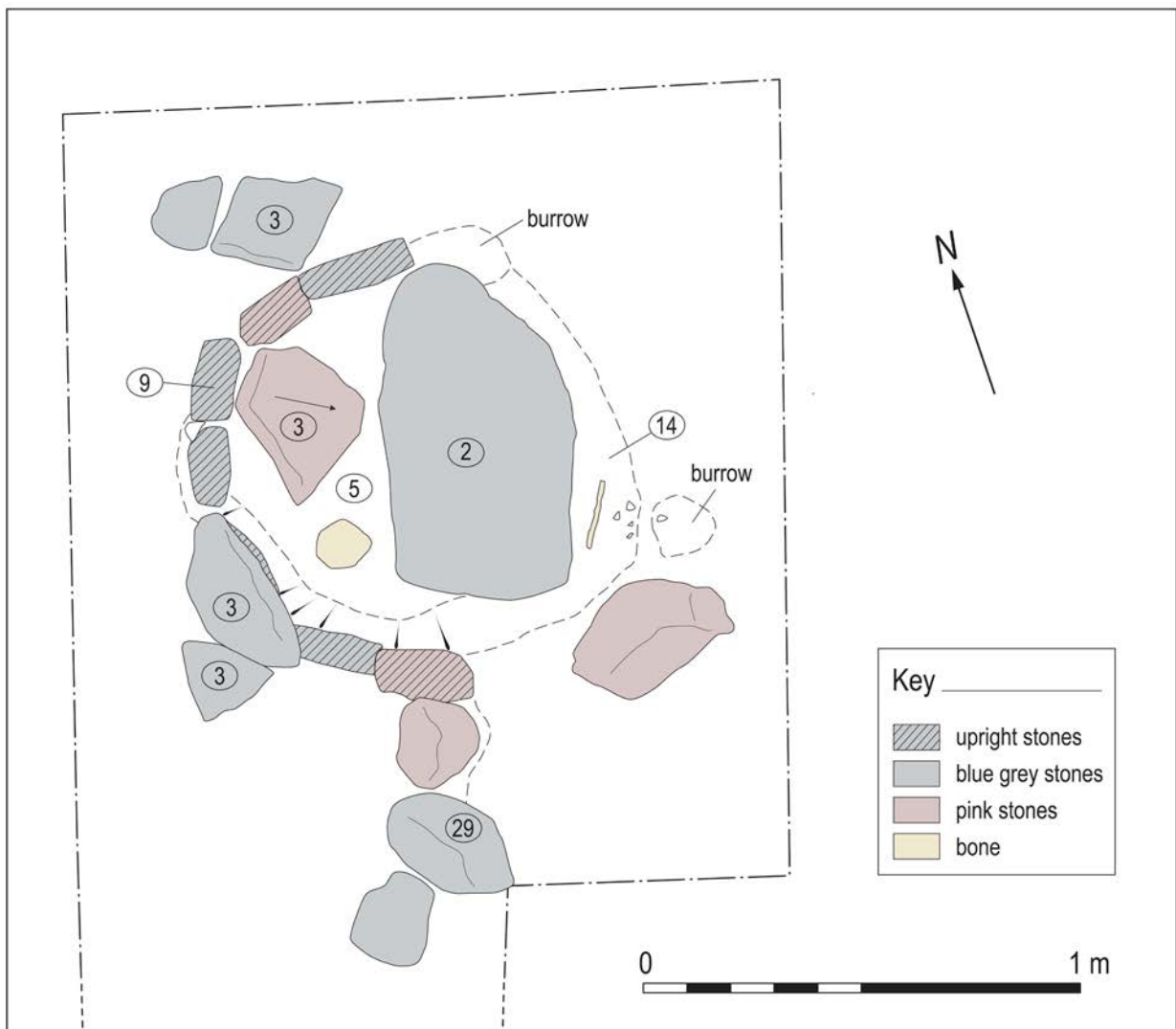

Illus 4 Plan of the stone-lined grave in Area A, showing the partly displaced covering slabs



Illus 5 Plan of the burial in Area A

They appeared at first to represent a skeleton in a crouched position, lying on the right side. However, on excavation the skeleton proved to be incomplete and not fully articulated, and closer analysis and radiocarbon dating have established that bones from at least two other individuals were also placed in the setting.

The bones lay in a consistent matrix of firm, red-brown silty sand (Context 5); the colour was strongest around the bones, especially to the east of the cranium, around the lower leg and right knee and around the pelvis, where it was particularly well defined. Around the head, the base of the red-brown sand was concreted onto the underlying packing sand (C14). Across the centre of the burial, the matrix was greasier and flecked with black (C11),

with a very dense black concentration around an isolated right upper arm bone (humerus). Around an isolated left lower leg bone (fibula) lay darker brown sand mixed with sparse pale sand (C12).

The skull lay on the right side, facing south, and was articulated to the two uppermost vertebrae. It was very fragile and fractured during excavation. No facial bones survived except for the right side of the jaw and, although most of the teeth were present, few were in situ. Close to the right side of the skull were three fragments of boar’s tusk, one of them perforated, and a tooth from a probable juvenile seal (see 6.1 ‘Worked bone in Area A’ below). From their positions, they may have been worn on a necklace or in a bag strung on thread or sinew. Two distinctive concentrations of reddish sand, which held their

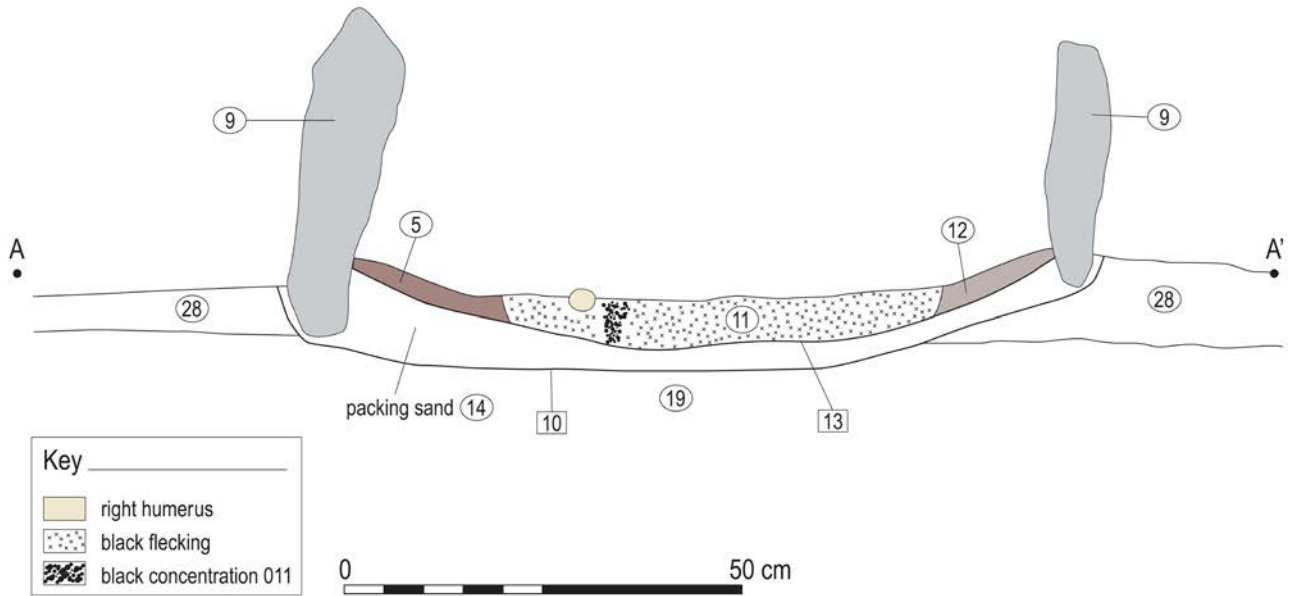

Illus 6 Section through the grave in Area A

form during gentle cleaning, lay by the head: one in a triangular shape on the forehead and another smaller, oval concentration to the south-east.

The torso also lay on the right side, separated from the head by a gap. The consistency of the red-brown burial matrix in the gap and the absence of any small bones seem to indicate that the head and torso were laid at the same time, but were separate. Both collar bones and shoulder blades were present, although they were poorly preserved; the sternum was missing and the ribs were very fragmentary. Most of the middle vertebrae were also present. During excavation, it was noted that several of the middle (thoracic) vertebrae were articulated with each other but lay near the right shoulder blade (scapula), out of alignment with the rest of the burial, suggesting that the body was in a state of partial decay when it was put in the pit.

Part of a lower left arm lay across the chest with the articulated left hand beneath the chin, including six out of eight small carpal bones of the wrist, indicating that the hand and wrist were still at least partly fleshed at the time of burial. The other bones of the left arm (humerus and ulna) had been disturbed and lifted during the initial discovery, but were available for post-excavation examination. A highly eroded right upper arm bone (humerus) lay isolated in the burial matrix to the east of the skull, as if in situ, but no other bones of the right arm were present.

Like the head, the pelvis and lower limbs were separated from the torso by a gap filled with the uniform burial matrix, with no evidence of disturbance. Very eroded lower vertebrae were articulated with the pelvis, as was the right thigh bone (femur). The right knee cap (patella) and the top of a right lower leg bone (proximal tibia epiphysis) lay at the position of the right knee, but the tibia itself and the right foot were absent. Two lower ends of the thigh bone (femoral epiphyses) – one unfused and from the left side, the other very eroded – lay in the knee position; the complete one sat directly above the eroded one. A lower right leg bone (fibula shaft) lay close to the femur as if the leg had been tightly flexed.

Apart from the left femoral epiphysis, the only other bone from a left leg was a lower leg bone (fibula). This lay by itself along the north side of the torso.

From the anomalous position of several of the bones, particularly the isolated left fibula, it is clear that the body was not fully articulated when it was buried. It may have been in several parts – head, thorax and lower body – with a right arm and a lower left leg lying separate. The slight dislocation of several vertebrae also suggests an advanced state of decomposition. Osteological analysis established that the remains on the whole were adolescent in age and possibly male, although there is slight

discrepancy between the dental age and the ages indicated by stages of fusion in the lower body (see 5.1 'Skeletal analysis' below).

Several other disarticulated bones were found within the stone setting, including a tooth and several bones from hands and feet; one hand bone duplicated a bone in the articulated left hand of the main burial. All of these elements must have come from older individuals than that (or those) represented by the main burial: they were less eroded and lighter in colour, and were fully fused and larger in size (see 5.1 'Skeletal analysis' below). Radiocarbon dates indicate that they derive from at least two other individuals (see Tables 8 & 9).

After the remains were placed in the pit, it was apparently covered with a large slab (Context 2) and several smaller slabs (C3), found lying over the burial and at angles against the arc of upright stones (Illus 4). These may have originally formed either a flat or a corbelled covering. When it was recorded during excavation, the large slab had already been lifted and replaced at least three times, so its original position is not known. Three stones (C29) found extending in a line southwards from the pit might be a remnant of a kerb retaining a sandy covering mound, as proposed for the nearby burial excavated by Dunwell et al (1995a).

4.2 Area C

As described above (see 2 'Introduction'), the human remains in Area C were discovered when a slot trench was excavated through the sand to the south of Area A to establish the relationship between the stone-lined pit and a sandy mound, around the edges of which stones were visible. The erosion of ground surfaces between the two had erased any stratigraphic relationship between them. Excavation discovered that in Area C largely disarticulated human remains had been placed on a kerbed, sandy mound in three clusters.

The mound had been built by first heaping clean shell sand (Context 26) 0.4m thick onto the ground surface (C24), represented by a thin layer of mid-brown sand (Illus 7). Large slabs (C16) were set around and against the clean sand to form a partial kerb along the east, two courses high in places (Illus 8). The kerb did not appear to continue around to

the north-west and west, and the southern arc of the mound was not investigated. Next, slightly humic pale brown sand (C15) was heaped onto the mound, perhaps by people working from either side, as it rose up on the north and south, and then another course of slabs was laid on the kerb to retain the growing mound. The stones of the kerb were mainly gneiss, but included at least one smooth, weathered cobble of finer-grained rock.

Another, more mixed layer (Context 25) followed; it consisted of bands of lighter and darker brown sand as well as a lens of black silt. It lay 0.32m thick in the centre and also rose up to the north and south. On the north side, where this layer was thickest, people placed a cluster (1) of 112 disarticulated bones and bone fragments, representing at least two probable adults, an infant and a sub-adult of unknown age (5.1 'Skeletal analysis' below).

The remains in Cluster 1 were dominated by the bones of the chest region, hands and feet, some skull fragments, teeth and parts of long bones (5.1 'Skeletal analysis' below). Bones from the torso comprised several rib fragments and vertebrae (including two duplicated vertebrae, both C2) and small fragments of shoulder blade (scapula). There were a few fragments of skull, including one from an infant, and several teeth. There were no complete long bones, but some ends and fragments of arm and leg bones from individuals of different ages. A small bronze awl (SF14, Illus 22) was found at the northern edge of the cluster.

Next, more sand (Contexts 17 and 18) was heaped onto the mound, filling its dished centre (Illus 7 & 8). On the level surface people placed more human remains, this time in two groups (Clusters 2 and 3; Illus 9 & 10). The clusters lay roughly east/west and parallel to each other, and the sand was stained darker brown around the bones. The bones represented at least two adults, probably females, an infant and a child of six or seven (5.1 'Skeletal analysis' below). Illus 10 shows some of the elements in plan, according to age where this could be determined.

The remains included a similar range of bones to those in the stratigraphically earlier Cluster 1, but also pelvic bones and more complete long bones. A few of the more than 100 elements were articulated with each other, including two lower arm

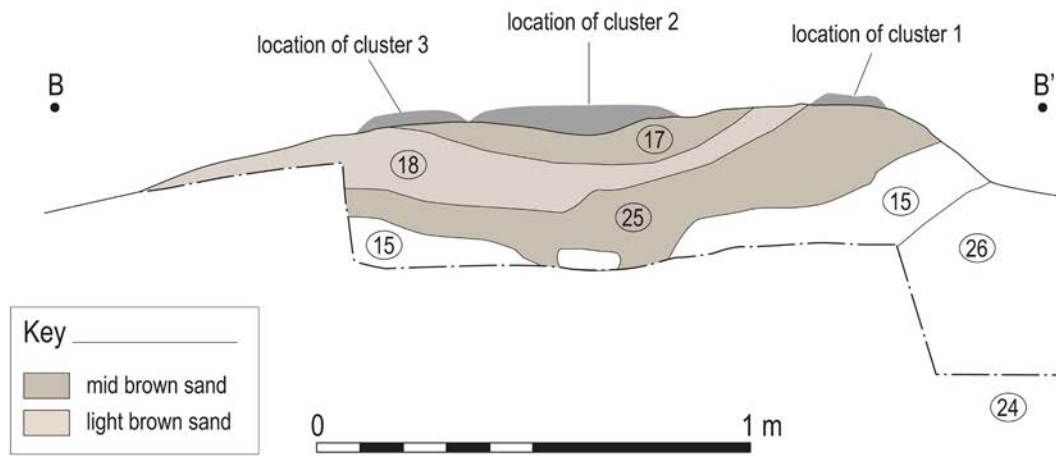

Illus 7 Section through the kerbed mound in Area C showing its make-up (above), and a view of the burials from the north-west after the excavation of Cluster 1

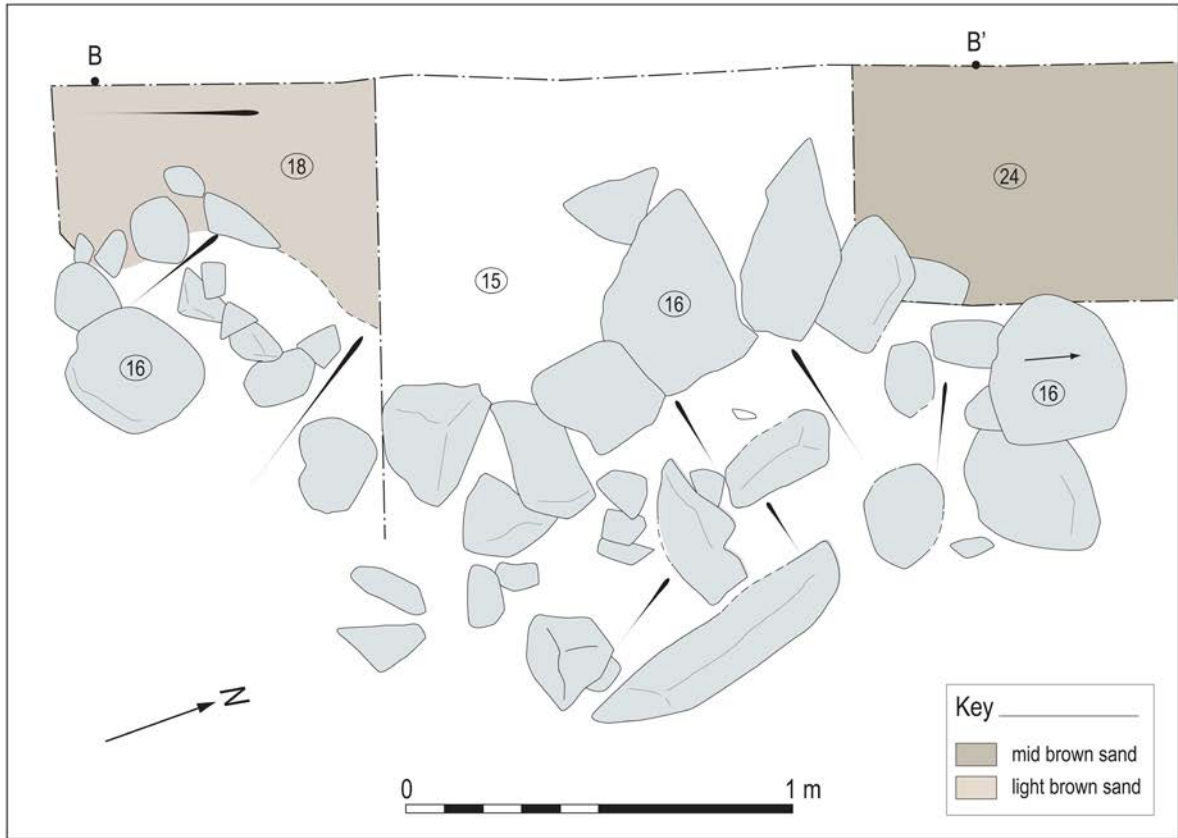

Illus 8 Post-excavation plan and photograph of the kerbed mound

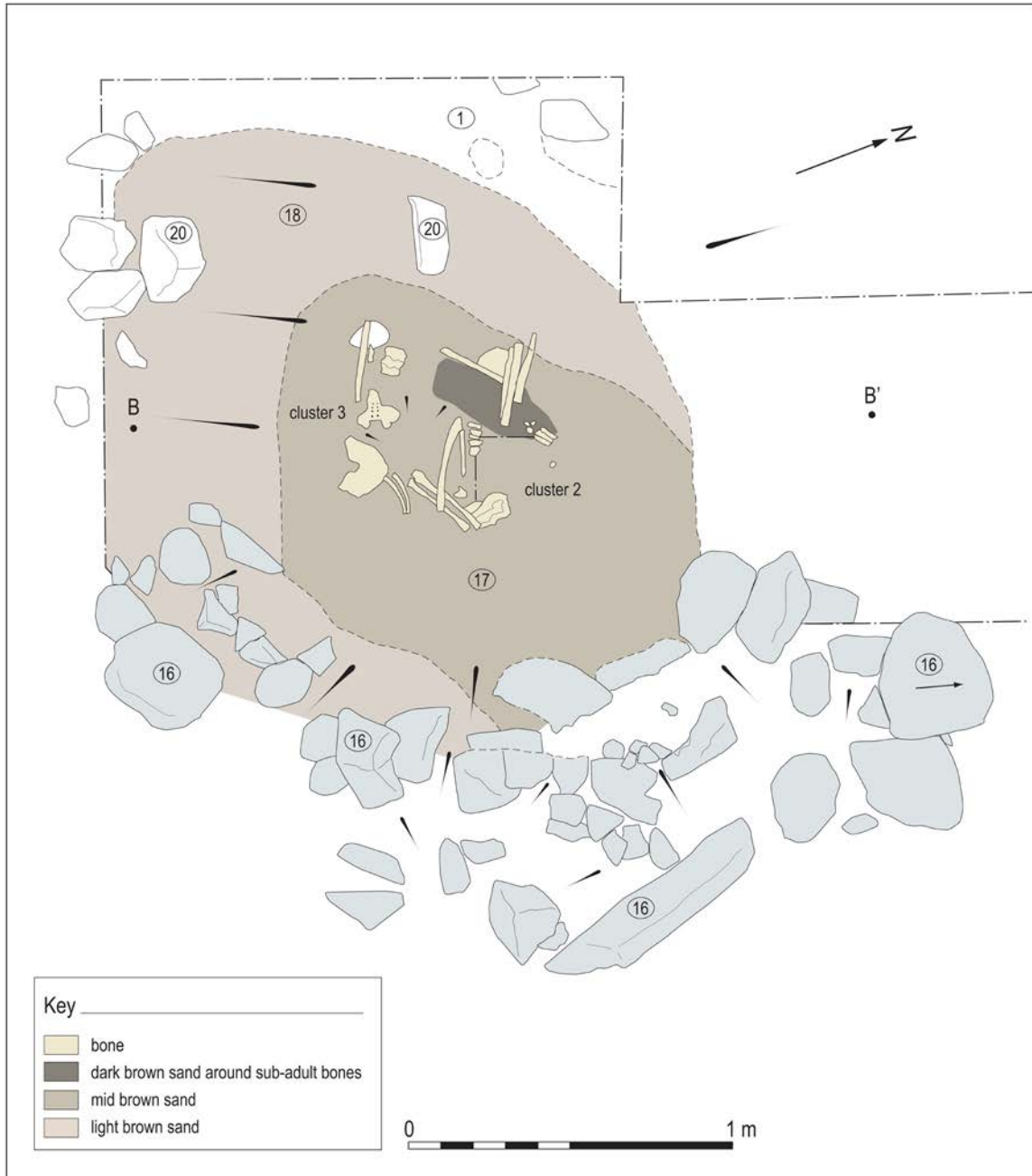

Illus 9 Plan of the human remains in Area C

bones (an adult’s radius and ulna, SF19) in Cluster 2. Many others had been laid in approximately correct anatomical position, although they were not articulated with each other, and elements from individuals of different ages were often combined. For example, in both clusters a sacrum from the lower back lay adjacent to a pelvis (a left pelvis, SF26, in Cluster 2 and a right, SF40, in Cluster 3), in roughly the correct relative position and alignment; the sacrum and pelvis in Cluster 2 came from the same adult (5.1 ‘Skeletal analysis’ below). Several

articulated vertebrae (SF36) lay in roughly the right position and alignment relative to the adult’s sacrum and pelvis in Cluster 3, although the vertebrae were those of a sub-adult. An arm bone (radius, SF37) of indeterminate age lay parallel to the vertebrae, where a lower arm would be expected to lie.

Another group of bones of sub-adult age in Cluster 2 comprised two leg bones (SF31) and an upper arm bone (SF30), lying parallel to each other, and another lower leg bone (SF32), all set on top of some large skull fragments (SF34, on which

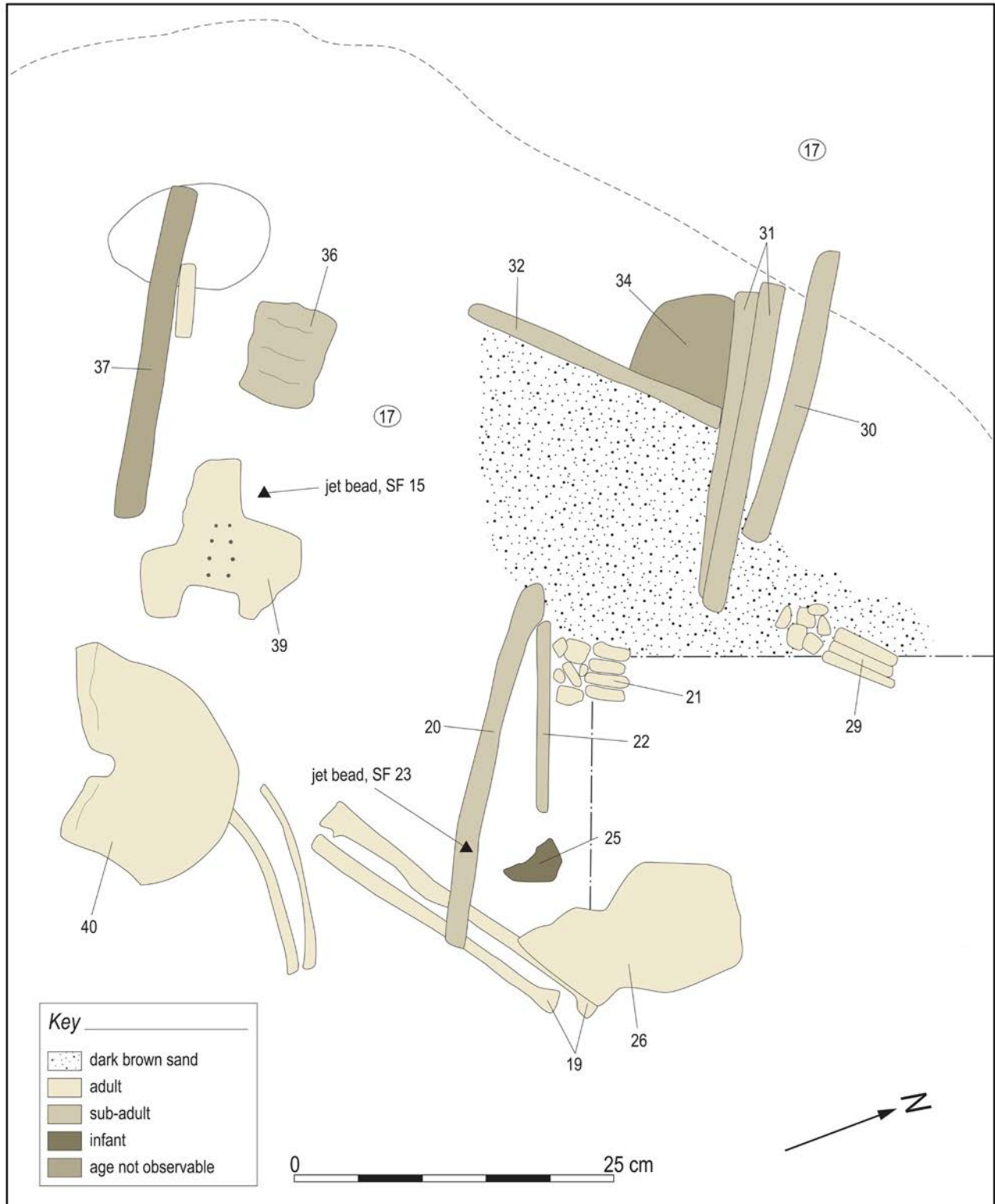

Illus 10 Clusters 2 and 3 in Area C, with bones shaded according to age

age was not observable). The sand around this group was darker brown (Illus 9 & 10), perhaps indicating that the bones had been wrapped in cloth or other organic material. What appeared at first to be an articulated hand (SF29) in Cluster 2 proved to be composed of six hand bones (carpals, a metacarpal and a proximal phalange) and a foot bone (intermediate phalange) (5.1 'Skeletal analysis' below). Nearby was an arrangement of three foot bones (metatarsals) and a hand phalange, laid carefully parallel above an ankle bone (talus) (SF21).

Whoever positioned the bones also placed two jet beads with them. A fusiform bead (SF15) was found next to the sacrum in Cluster 3, and a chunky rectangular bead (SF23) was found beneath a thigh bone (femur) in Cluster 2 (Illus 22–25).

Although the human remains lay in three clusters in two successive deposits, it is likely that the mound was built and the remains were placed in quick succession, then covered with more sand and capped with turf or stone. This rapid sequence of events preserved the carefully composed configurations of even the smallest bones.

4.3 Area D

The third burial, excavated in 2009 by Carol Knott (Knott 2010), lay 4.5m to the east of the cairn and 2m to the north of the stone-lined grave in Area A (Illus 1, 3 & 11). Excavation found that the earliest event was a small pit (C115), scooped into the grey-white shell sand (C109). It held the remains of an infant (Sk 3), aged birth ± two months, lying on its back in the foetal position with the head to the south-east, facing north (Illus 12 & 13). The bones lay in dark brown silty sand (C108), which may have been stained through the decay of some organic material in which the body was wrapped; Illus 12 shows the human remains after partial excavation of the burial matrix. The surrounding matrix was darker grey-brown with black greasy flecks (C116) on the north-east. Several marine shells had been placed with the body: a complete oyster shell lay near the skull, a limpet shell lay beneath the right arm (humerus), and several other limpet shells were found with the burial. The way that both burial matrices (C108, C116) extended beyond the lip of the pit (Illus 12) indicates that they derived from some material that was heaped up over the inhumation, and this had sunk in the centre as the

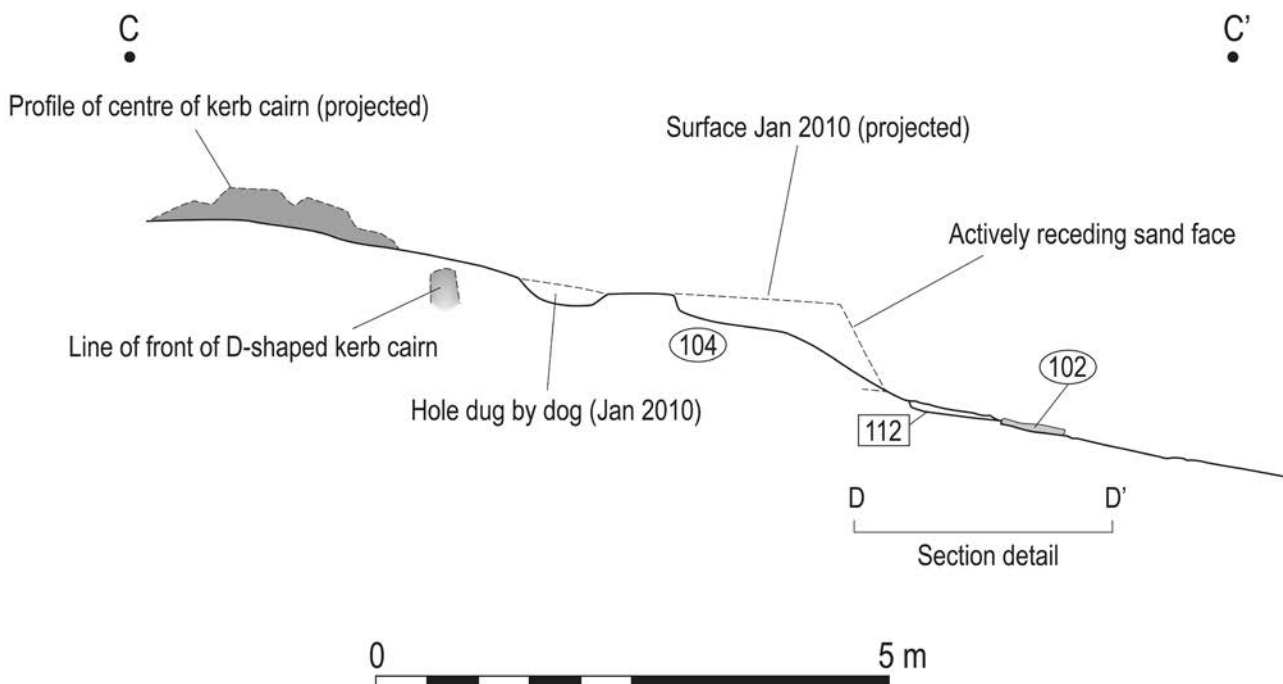

Illus 11 Profile across the Early Bronze Age cairn and Area D

body decayed and finally was covered with a thin layer of windblown sand (C113) (Illus 13).

Some time afterwards, another shallow pit (Context 112) was scooped out directly above and extending to the west (Knott 2010). Although the skeletal remains it contained were very fragmentary and in poor condition, most of the elements were embedded in the burial matrix and appeared to be in situ (Illus 14). They were those of a probable female adult (Sk 2; see 5.1 ‘Skeletal analysis’ below) and the burial exhibited similarities with the one in Area A: the positions of the bones indicate that the body was not fully articulated at burial. The remains lay in a firm, consistent matrix of reddish-brown, slightly silty sand (Context 103), which showed no signs of disturbance, although recent erosion of the surface

had displaced some smaller bones. The head lay to the south-west and the position of the collapsed mandible showed that it had been laid on its left side, facing north or north-west. At least 14 teeth, all dislodged, were recovered. One collar bone (clavicle) and shoulder blade (scapula) survived. The left arm was extended straight and included the humerus, radius and ulna, but the bones of the hand were scattered. Although the ribs were very fragmented, the position of the rib cage could be discerned to the ENE of the head.

Most of the upper and middle (cervical and thoracic) vertebrae were missing, but several articulated lower (lumbar) vertebrae and a fragmentary right pelvis lay in the eastern part of the burial matrix; their positions indicate that the

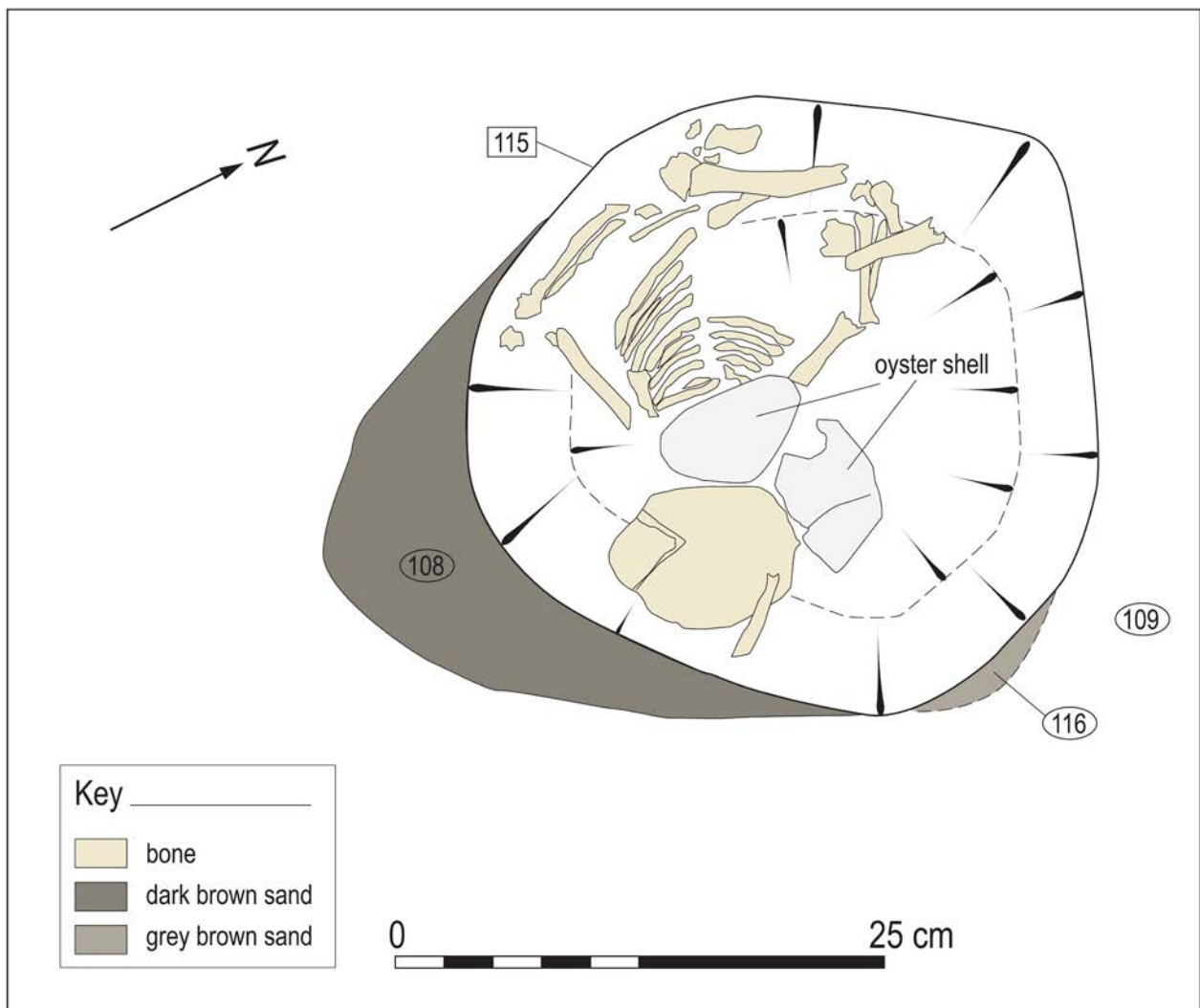

Illus 12 Plan of the infant burial in Area D

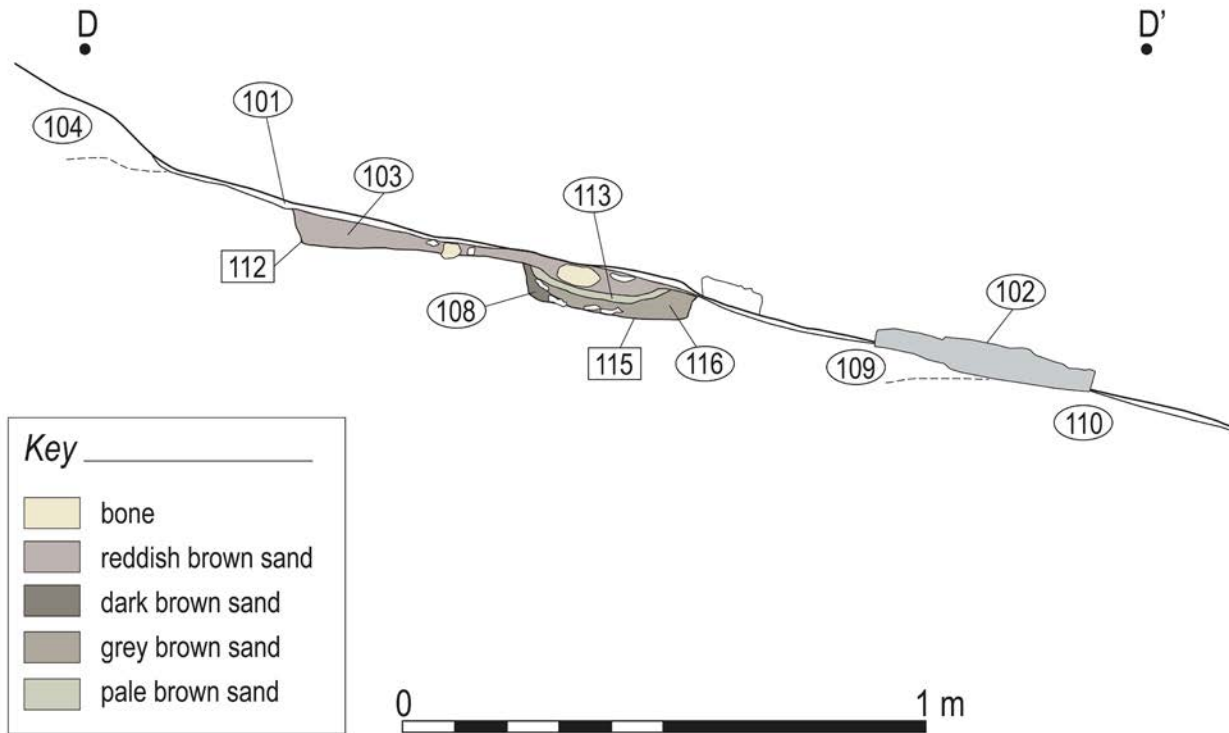

Illus 13 South-east facing section through the Area D burials

torso lay approximately east/west. Part of a single left leg (fragments of the fibula, patella and femur) lay in the northern part of the matrix, positioned as if tightly flexed. They were clearly not articulated with the pelvis, which lay 0.18m away from the head of the thigh bone (femur).

The surviving vertebrae and pelvis fragments lay in a slight depression, a sinkage hollow filled with windblown sand (Context 113) above the infant burial (Illus 13). Two infant hand bones (proximal phalanges) and a fragment of long bone shaft were found among the adult bones; these were probably disturbed during the second phase of burial. In that case, the infant's bones were defleshed by the time the woman was buried above.

A large slab of local gneiss (Context 102) lay immediately downslope from the burial, along with a few smaller, flat stones (Illus 13 & 14). The slab lay on a thin spread of loose windblown sand (C101), which had accumulated recently and contained small stones and marine shells, much of which may have washed down from the cairn, as well as abraded flakes of human bone from the eroding burial. The large slab may have been some kind of dislodged

covering for the burial, but equally it may have come from the cairn upslope or another structure, such as a disturbed grave, nearby (Knott 2010).

5. THE HUMAN REMAINS

5.1 Skeletal analysis

Maureen Kilpatrick

The bones recovered from the 2009 and 2010 excavations were studied to establish the minimum of number of individuals represented, determine their age at death and sex, identify evidence of pathology, growth and development and record metric and non-metric data. Osteological analysis followed current discipline standards and guidelines, as outlined by Ubelaker (1989), Buikstra & Ubelaker (1994), Bass (1995), Mays (1998), English Heritage (Mays et al 2002), the British Association of Biological Anthropologists and Osteologists/Institute of Field Archaeologists (Brickley & McKinley 2004), Scheuer & Black (2004) and Albert et al (2010). Table 1 outlines the age categories used during the analysis.

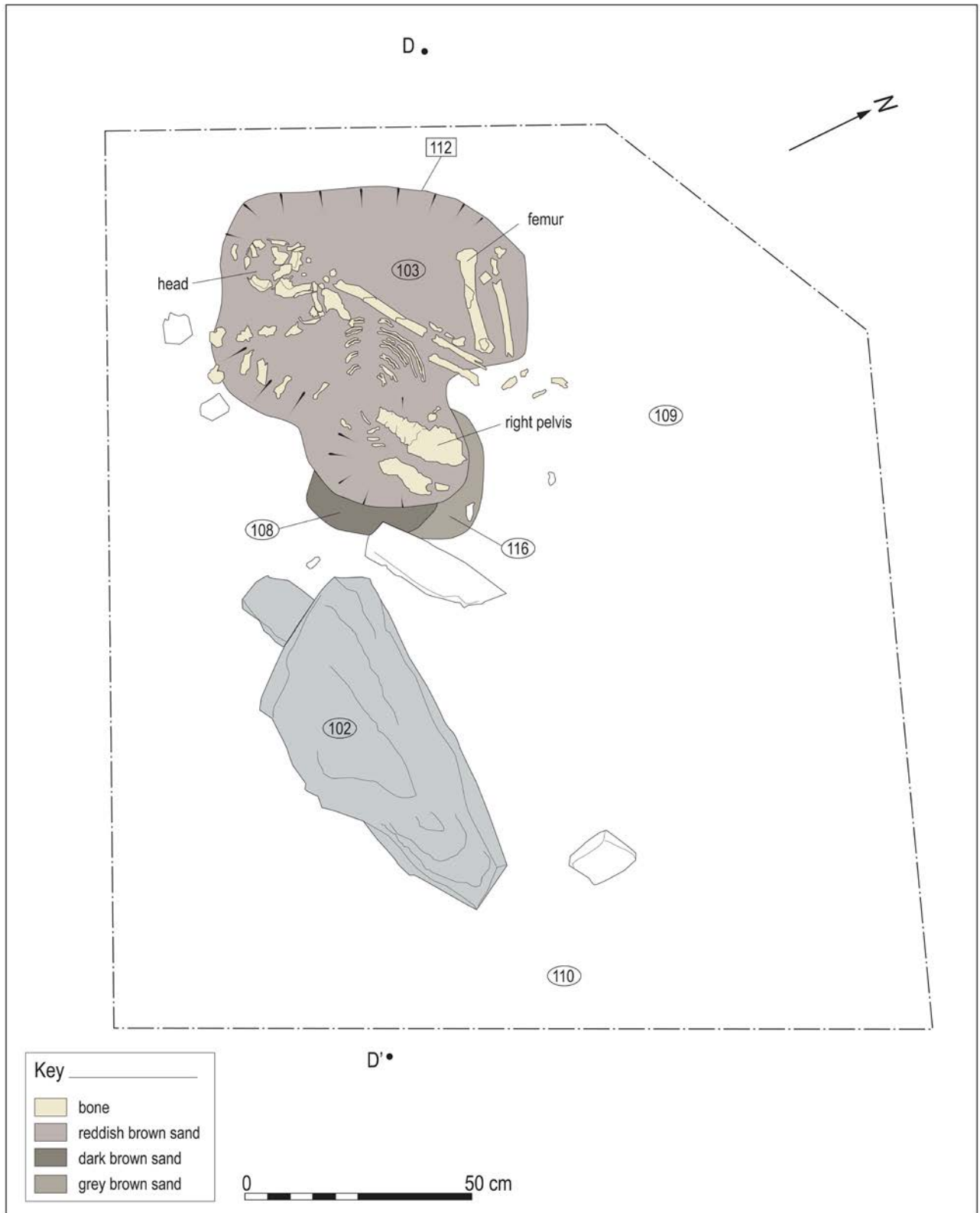

Illus 14 Plan of the adult burial in Area D

Table 1 Age categories (from Buikstra & Ubelaker 1994: 9)

Category	Age range
Foetal	< birth
Infants	birth – 3 years
Children	3–12 years
Adolescents	12–20 years
Young Adult (YAd)	20–35 years
Middle Adults (MAd)	35–50 years
Old Adults (OAd)	50 + years

Certain constraints attended the analysis. At present there are no reliable methods of attributing sex to sub-adult remains, although it may be possible with older children around the onset of puberty. Due to the partial and fragmentary state of the lower long bones, only the upper arm bones were available for estimating height; however, research by Molleson & Cox (1993) suggests that arm bone length can underestimate height by up to 0.10m in comparison to height taken from lower long bone length. The fragmentary and partially disarticulated nature of the bone made it difficult to diagnose disease.

5.1.1 Area A

Most of the bone had erosion (mainly grade 3, with some bones displaying grade 4) caused by plant root infiltration. About 60% of an individual (Sk 1) was recovered, with most paired skeletal elements represented at least once.

During excavation and analysis it became apparent that the burial contained the remains of at least two and possibly three individuals. One was represented by Sk 1, and at least one other individual was represented by several small disarticulated bones found in the cist (see below).

The main burial (Sk 1) was a possible male, based on the morphological characteristics of the nuchal crest, mandible of the skull and the sciatic notch of the pelvis, with age at death estimated as adolescent (12–20 years old). While overall the indicators of age fell in this range, there was some variation between them across the body and in particular a discrepancy between the dental age and the lower body; these are summarised in Table 2. This could indicate that the head and the lower body are from different individuals, but equally it could be a natural variant. Unfortunately, long bone length could not be used because of post-mortem deterioration of the bones and stature could not be calculated for the same reason.

The cranium was very fragmentary, although the lambdoid cranial suture line survived and had only minimal closure (Meindl & Lovejoy 1985). No facial bones survived except the right side of the mandible, and this was very poorly preserved. Most of the dentition survived, although the roots and enamel were eroded and most were not in situ, and indicated an age of 14.1–14.8 years. The surviving cervical vertebrae (C1 and C2) appeared fully fused, with three other fragmentary cervical arches also present.

The thoracic section of the burial and its associated bones suggested an age range of

Table 2 Indicators of age in Skeleton 1 from Area A

Body area	Estimated age at death	Indicator
Head	14.1–14.8 years	Partially intact root of third molar
Thorax	< 18 years?	Fusion range of thoracic vertebrae, surface billowing
Upper limb	12 years +	Fused distal end of left humerus
Upper limb	< 20 years	Unfused epiphyseal plate on distal end of left ulna
Lower limb	16–20 years	Unfused distal femoral diaphysis
Lower limb	14–17 years	Fully fused innominate
Lower limb	16 years +	Proximal head and lesser trochanter of right femur fully fused
Lower limb	15 years +	Fully fused distal end of left fibula

between 12 and 20 years of age. The distal radial epiphysis had a slightly darker colour to its cortex than its corresponding radial shaft. The highly eroded right humerus, which lay to the east of the skull, had both proximal and distal ends missing post mortem. The thoracic vertebrae, which were observed during excavation to be articulated with each other but slightly out of alignment with the rest of the burial, were identified as a fragmentary possible T9, T10 and T11, as well as a lumbar vertebra (L1). This confirmed that decomposition was probably well advanced at the time of deposition.

As with the thoracic and cranial sections, the pelvis and lower limb section of the body was separated from the upper body. Overall the bones of the lower body indicated an age range of 14–20 years, with some elements indicating an age greater than 15 or 16 (see Table 2). The surviving lumbar vertebrae (L3–L5) were, like the thoracic vertebrae, very eroded and no annular rings were present. L5 had some evidence of billowing on one of its body surfaces. The first and second sacral bodies were also present, although much eroded, and did not appear fused. Articulated to the sacrum was a badly eroded right pelvic innominate with both the iliac crest and pubic bone missing post mortem. A small fragment of iliac crest was recovered, although it is not known if this was even partially fused and had become dislodged at a later date. The right femur was articulated to the innominate and was tightly flexed. Due to the disarticulation of the left fibula, it is not clear whether it is related to Sk 1. However, it had similar surface erosion and was of similar size, which could indicate that it was related although placed in an incongruous position beside the upper body.

No pathology was evident except for dental attrition, observed on several teeth. The labial positioned teeth, which included most of the incisors, had slight attrition on their occlusal surfaces. The upper left canine and the first molars also had slight dental wear on their surfaces. Dental attrition can be the result of erosion on the surface of the tooth through eating acidic or coarse food, which causes pressure on the occlusal surfaces and leads to destruction of the enamel (Roberts & Manchester 1999; Ortner 2003).

As mentioned above, bones from at least one other individual were recovered from the stone-lined pit

and immediate vicinity. A lunate from a right hand (SF10), which was much larger than the lunate in the left hand of Sk 1, was found near the disturbed left humerus and a left third hand metacarpal was found next to the right humerus; they were larger than the left lunate and left third hand metacarpal of Sk 1. A foot metatarsal (SF5) was found immediately south of Sk 1. A permanent incisor (SF4) found outside the grave on the north-west had severe dental attrition, but the root appeared intact with no surface erosion, unlike the teeth associated with Sk 1. Two hand bones, a fourth and fifth metatarsal (SF54), were found in the packing sand (Context 14) beneath the absent right foot of Sk 1. A distal foot phalange and sesamoid bone (SF6) were also found inside the cist, below the disturbed capping stones. Of the two distal femoral epiphyses found lying superimposed and approximately in the knee position, the lower was severely eroded, making a definite identification difficult, but it may have been an unfused element from the left side like the better-preserved epiphysis that lay directly above it, and in that case would represent a separate individual. During post-excavation analysis of the skeletal remains, a fully formed talus from an adult foot was found adhering to thoracic vertebrae of Sk 1.

Except for the eroded femoral epiphysis, these bones had less eroded cortical surfaces than Sk 1, they were smoother and lighter in colour, and they tended to be larger and were fully fused. A minimum of one individual was represented by this disarticulated bone. Despite their similarities in size and surface erosion, it is impossible to say on osteological grounds whether these bones are from one or multiple individuals; however, radiocarbon dates indicate that they represent more than one (see Tables 8 & 9).

5.1.2 Area C

The disarticulated and partly articulated remains from Area C comprised 161 bones and at least 52 small bone fragments. The surface preservation of the bone was similar to that of Sk 1. Surface erosion and plant root impressions were found on most bone surfaces, although the bone did not have the slightly darker colouring found on Sk 1.

The remains of at least four individuals were recovered from each of two separate contexts in

Area C. Context 25, the stratigraphically lower sand making up the kerbed mound, contained at least 112 bones and bone fragments representing two probable adults, an infant and a sub-adult of unknown age (see Table 3). The identification of the two probable adults was based on the presence of two fused cervical axis vertebrae (C2) (SF18) and two much-eroded right temporal petrous bones of the skull (SF16 and SF18). The very fragmentary remains of a probable infant consisted of several very thin and delicate cranial fragments (SF18), a facial right zygomatic bone of infant size (SF17) and a possible infant long bone (SF18). Two unfused epiphyses of a femur and tibia and a proximal hand phalange (SF18) were also present, representing at least one other sub-adult of unknown age. Due to the disarticulated state of the bones and the non-survival of most of the areas used in age estimation, much of the bone from Context 25 could not be assigned an age with any certainty, but only within the broad age categories of adult (older than 20), sub-adult (younger than 20) and infant (birth to three years).

The stratigraphically later Context 17 contained at least 101 bones and bone fragments, representing at least two adults, an infant and a sub-adult of six to seven years (see Table 4). The two adult individuals were identified from two fully fused innominate bones (SF26 and SF40). Both bones had predominantly female characteristics (based on the sciatic notch, sub-pubic concavity and ischio-pubic ramus) and similar stages of erosion on their auricular surfaces. Although they were of opposing sides and shared similarities, there were slight differences in the size and shape of the auricular surfaces, indicating that they had to be from different individuals. This was further supported when one innominate (SF26 in Cluster 2) fully articulated with the sacrum (SF47) that lay adjacent, indicating that they came from the same individual, while the other (SF40 in Cluster 3) did not articulate with it. Another, much-eroded sacrum (SF39) was found next to the latter innominate, which again indicated that the remains of at least two adults were present in this layer. The degenerative changes to the auricular surfaces of the pelvic ilium indicate that both women were 40–44 years old when they died.

A small right temporal bone (SF25) in Context 17, with a partially fused temporal ring

and incomplete closure between its petrous and squamous portions, represented an infant. The layer contained several other bones of sub-adult age that appeared developmentally older than the infant temporal bone. These included unfused right and left tibia, one of which (SF31) was attributed an age of six to seven years at death (approximate only, based on long bone length (Scheuer & Black 2000)). An unfused left femur (SF50) and two unfused right and left pelvic iliums (SF36 and SF52) indicated a fusion age of less than 17 years at death. A fragment of cranial sphenoid bone (SF55) was also that of a sub-adult.

The only fully fused long bones that could be used to calculate stature were a mutually articulated radius and ulna (SF19) in Cluster 2. Using Trotter's (1970) formulae for white female individuals, a height of 158.53cm \pm 4.30 (5 feet 2 inches) was obtained from the ulna and 154.47cm \pm 47.24 (5 feet 1 inch) from the radius. However, the difficulty in obtaining accurate height when using lower arm bones must be reiterated.

Most of the remains within the mound had surface erosion with loss of bone, which made the survival and diagnosis of any residual pathology difficult. An adult sacrum (SF47) in Context 17 had slight degenerative changes around the margin of the first sacral body, while a right innominate (SF40) had slight bony growths to the posterior of the auricular surface, both thought to be age-related changes. Two permanent incisors in the same context had slight to moderate attrition on their occlusal surfaces.

Taking the mound as a whole, most of the major bones of the body were represented except the sternum. Both legs, arms, hands, feet and pelvis were all present, with little duplication between adult bones and sub-adult bones. For example, the bones of the legs were predominantly those of sub-adult individuals while bones of the hands, feet and thorax generally came from probable adults. Very few cranial bones survived and most were sub-adult in age except for two highly eroded petrous bones, which were thought to be adult. There was slight overlap at the pelvis, where adult innominate and sub-adult ilium bones were present (Context 17), and at the arms where both adult and sub-adult were represented; several sub-adult hand phalanges were also present, along with the predominantly adult bones of the hands.

Table 3 Bones from Context 25 (Cluster 1) for which age was observable (assignments to Adult are tentative, based on complete fusion, relative size and age-related degenerative changes)

SF	Element	Side	Age	SF	Element	Side	Age
12	Metatarsal	R	Adult	18	Cervical vertebra C2		Adult
12	Rib fragment	R	Adult	18	Patella	R	Adult
13	Calcaneus	L	Adult	18	Proximal hand phalange	NO	Adult
16	Rib	R	Adult	18	Rib fragment	L	Adult
16	Proximal hand phalange	NO	Adult	18	Cervical vertebra C2		Adult
16	Proximal hand phalange	NO	Adult	18	Cervical vertebra ?C4		Adult
16	Proximal hand phalange	NO	Adult	18	Proximal hand phalange	NO	Adult
16	Proximal hand phalange	NO	Adult	18	1st metatarsal	L	Adult
16	Proximal hand phalange	NO	Adult	18	1st distal foot phalange	?R	Adult
16	Intermediate hand phalange	NO	Adult	18	Intermediate foot phalange	NO	Adult
16	Proximal foot phalange	NO	Adult	18	Lunate	L	Adult
16	Proximal foot phalange	NO	Adult	18	Scaphoid	L	Adult
16	Cervical vertebra (atlas)		Adult	18	Trapezium	R	Adult
16	Radius	R	Adult	18	Capitate	L	Adult
16	1st distal foot phalange	R	Adult	18	Petrous	R	Adult
16	Proximal foot phalange	NO	Adult	12	Calcaneus	R	Adult
16	Lunate	R	Adult	18	Fibula shaft fragment	L	Adult
16	1st metacarpal	R	Adult	11	Cranial fragment	NO	Sub-adult
16	Petrous	R	Adult	16	Femur distal epiphyses	?R	Sub-adult
17	Rib fragment	R	Adult	16	Tibia proximal epiphyses	L	Sub-adult
17	Rib fragment	R	Adult	16	Long bone shaft	NO	?Infant
17	Lumbar vertebra ?L3		Adult	16	?Femoral head	NO	Sub-adult
17	Scaphoid	R	Adult	16	Cranial fragments	NO	Sub-adult
17	Hamate	L	Adult	17	Zygomatic	R	Infant
17	1st proximal foot phalange	R	Adult	18	Parietal frags	NO	?Infant
17	2nd incisor	L	Adult	18	Cranial frags	NO	Sub-adult
17	Metatarsal shaft	NO	Adult	18	Proximal hand phalange	NO	Sub-adult

Table 4 Bones from Context 17 for which age was observable (assignments to Adult are tentative, based on complete fusion, relative size and age-related degenerative changes)

SF	Element	Side	Age	SF	Element	Side	Age
19	Ulna	R	Adult	46	Talus	R	Adult
19	Radius	R	Adult	47	Sacrum		Adult
21	Talus	L	Adult	48	Clavicle	R	Adult
21	Hand phalange	NO	Adult	49	Calcaneus	L	Adult
21	1st metatarsal	R	Adult	49	Cuboid fragment	R	Adult
21	2nd metatarsal	R	Adult	53	Proximal hand phalange	NO	Adult
21	3rd metatarsal	R	Adult	53	Cervical vertebrae		Adult
26	Innominate	L	Adult	55	2nd metacarpal	L	Adult
27	Thoracic vertebra ?T11		Adult	55	Proximal hand phalange	NO	Adult
28	Lumbar vertebra L4		Adult	55	Proximal foot phalange	NO	Adult
29	3rd metacarpal	R	Adult	55	Triquetral	?L	Adult
29	Int foot phalange	NO	Adult	55	5th metacarpal	R	Adult
29	Hamate	R	Adult	20	Femur shaft	R	Sub-adult
29	Hamate	L	Adult	22	Humerus shaft	NO	Sub-adult
29	Scaphoid	R	Adult	25	Petrous	R	Infant
29	Capitate	?R	Adult	29	Proximal hand phalange	NO	?Child
29	Triquetral	R	Adult	30	Humerus	R	Sub-adult
29	Pisiform	NO	Adult	31	Tibia shaft	R	Child (6-7)
35	Proximal hand phalange	NO	Adult	31	Fibula shaft fragment	?L	Sub-adult
37	Rib fragment	R	Adult	32	Tibia shaft	L	Sub-adult
39	Sacrum frags		Adult	36	Ilium	L	?Child
39	Rib fragment	L	Adult	36	Lumbar vertebrae		Sub-adult
40	Innominate	R	Adult	42	Cranial fragments		?Sub-adult
41	1st incisor	L	Adult	50	Femur shaft	L	Sub-adult
41	2nd metacarpal	R	Adult	52	Ilium	R	?Child
41	2nd incisor	?L	Adult	55	Femur distal epiphyses	L	Sub-adult
43	1st metacarpal	L	Adult	55	Proximal hand phalange	NO	Sub-adult
43	Lumbar vertebra L5		Adult	55	Sphenoid	NO	Sub-adult
44	Rib frags	R	Adult	55	Sphenoid	NO	Sub-adult
45	Proximal foot phalange	NO	Adult				

5.1.3 Area D

The surface erosion of the bone recovered from Area D was graded as 3 (Brickley & McKinley 2004). Much of the bone was very fragmentary and several fragments were white in colour with smooth cortex, probably the result of surface exposure and weathering.

The upper burial contained the remains of one individual (Sk 2). Two small proximal hand phalanges found with it may have derived from the infant burial (Sk 3) below. The mastoid process and posterior zygomatic process of the skull indicated that the individual was probably a female, as did the sciatic notch and pubic ventral arch. Age at death was estimated as middle adult (40–44 years) based on the morphological changes to the auricular surface only (Lovejoy et al 1985). The third molar was present and fully erupted, although due to post-mortem erosion no other age estimation methods could be employed. Stature could not be estimated due to the fragmentary state of the long bones.

Dental attrition or wear was evident on most teeth, with the molars most affected. Several teeth, including a first premolar, had only the roots surviving and a peri-apical abscess had formed at the base of the root. This was probably due to the exposure of the internal pulp cavity, which had allowed the transmission of bacteria and infection into the surrounding alveolar bone. As a result, the alveolar bone had been reabsorbed and several adjacent teeth had been lost during life. Sub-gingival calculus (mineralised plaque) was present on several teeth, along with a root caries on a third molar. Dental enamel hypoplasia was observed on a first molar; this enamel defect occurs during tooth development and is attributed to physiological stress, such as childhood infection and dietary deficiency (Roberts & Manchester 1999). The general picture is one of very poor or neglectful dental hygiene and probably a coarse diet.

The bones of the lower body, which consisted of a tightly flexed leg and a pelvic innominate, appeared to be from different sides. The innominate was right-sided, while the fibula, patella and femoral fragments were possibly left-sided.

The remains of one individual were represented in the lower burial – an infant aged birth ± two

months (Sk 3). At least 60% of the skeleton survived. Several teeth were present and unerupted within the mandibular crypts. One measurement could be obtained for an unfused pars basilaris, which suggested an age range in excess of 40 weeks. Most of the bones were incomplete due to post-mortem erosion, with grade 3 surface erosion. One non-metric trait, zygomatic facial foramen, was present on the right side but absent on the left. No pathology was observable.

5.2 Stable isotope analysis of the human remains

Jane Evans & Angela Lamb

In order to illuminate the diet and if possible the geographical origins of individuals buried at Cnip Headland, samples were submitted from an adolescent Sk 1 (Area A) and an adult female Sk 2 (Area D) for analysis of strontium and oxygen isotopes on tooth enamel and carbon, nitrogen and sulphur isotopes on bone. The samples were prepared following the methods described in Birck (1986), O'Neil et al (1994), Daux et al (2008) and Chenery et al (2010); full details are given in the archive report. The results are presented in Table 5.

The application of sulphur isotope analysis to archaeological material is relatively new, but can illuminate both palaeodiet and residency or mobility (Richards et al 2001; 2003; Privat et al 2007). Sulphur is a vital nutrient for animals, and an animal's sulphur composition derives from its food intake. Geology and soil processes influence the sulphur isotope signatures deriving from plant food intake. Near the coast, sea spray can deposit marine sulphur and potentially blur the terrestrial/marine $\delta^{34}\text{S}$ distinction, but different $\delta^{34}\text{S}$ values in marine, terrestrial and freshwater producers can be used to distinguish these sources. Away from areas affected by sea spray, $\delta^{34}\text{S}$ can distinguish between marine and terrestrially based diets (Krouse & Herbert 1988). The limitation of $\delta^{34}\text{S}$ for archaeological palaeodiet studies is that it may not be able to distinguish between truly marine diets and terrestrial diets in coastal locations due to the issue of sea spray. If it is used in combination with other palaeodietary isotopes (C, N) this may aid interpretations.

Stable isotope analysis had been carried out previously on samples from the Bronze Age burial

Table 5 Stable isotope data for Skeletons 1 and 2 from Cnip Headland (* a ±0.2 (1s) blanket error, derived from the reproducibility of the NBS 120 C standard, is considered the best estimate of error for the δ¹⁸O SMOW values and this results in ±0.4 (1s) error on the calculated drinking water values)

Sample	ppm	87Sr/86Sr	mean δ ¹⁸ O SMOW	n	Daux equation	Amt % N	Amt % C	at C/N	δ ¹⁵ N AIR	1 SD	δ ¹³ C P	1 SD	N
Cnip-A-Sk1	232.5	0.709606	18.24	2	-5.7	14.6	41.7	3.3	11.47	0.2	-18.86	0.11	3
Cnip-D-Sk2	320.2	0.709346	18.87	3	-4.6	11.8	33.7	3.3	9.08	0.3	-20.18	0.10	2

excavated near the cairn (Dunwell et al 1995a) and from the early Norse-period cemetery in the same deflation hollow (Dunwell et al 1995b). This established that the man who had died in the 2nd millennium BC was probably of local origin, as were all but two of the Norse-period individuals (Richards et al 2001; Montgomery et al 2003).

5.2.1 Strontium

The two individuals from Cnip Headland show the elevated strontium concentrations and the seawater strontium isotope compositions that typify coastal dwellers of the region (see Table 5) (Montgomery et al 2003). Their oxygen isotope signatures are consistent with the temperate climate zones of the Outer Hebrides (-4 to -6) and therefore with a local origin on Lewis or elsewhere in the island.

5.2.2 Carbon and nitrogen

The carbon and nitrogen isotope composition for Sk 1 and Sk 2 has been compared with reference data from the previously analysed burials on Cnip Headland and at Galson, also on Lewis (Richards et al 2001), as well as burials from Newark Bay, an Iron Age site on Orkney (Richards et al 2006), and Wetwang, an Iron Age chariot burial in Yorkshire (Jay & Richards 2006). The Scottish data define an array of values that result from a mixed diet of marine and non-marine protein components; the higher nitrogen values typify a marine component. The Wetwang dataset provides a reference set for a diet high in animal protein, with no evidence for any significant marine food input (Jay & Richards 2006). The two Cnip individuals plot close to previous samples analysed from this site (Montgomery et al 2003). The data also plot within the array of data from Newark Bay on Orkney, showing that Sk 1 and Sk 2 had a mixed diet of animal and marine protein.

5.2.3 Sulphur

Sk 1 and Sk 2 show some diversity in the sulphur isotope δ¹³C despite their relatively restricted origin, while the δ³⁴S values are the same for both individuals (15.8‰) but relatively low for what is normally observed for coastal dwellers (Illus 15 & Table 6). In both respects, they are broadly similar to

Table 6 Sulphur data for Skeletons 1 and 2 from Cnip Headland

Sample	$\delta^{34}\text{S}$ VCDT	1 SD	n	% S	Amt % N	Amt % C	Amt % S	at C/N	at C/S	at N/S
Cnip-A-Sk1	15.8	0.64	2	0.18	14.6	41.7	0.18	3.3	634	190
Cnip-D-Sk2	15.8	0.19	2	0.14	11.8	33.7	0.14	3.3	623	187

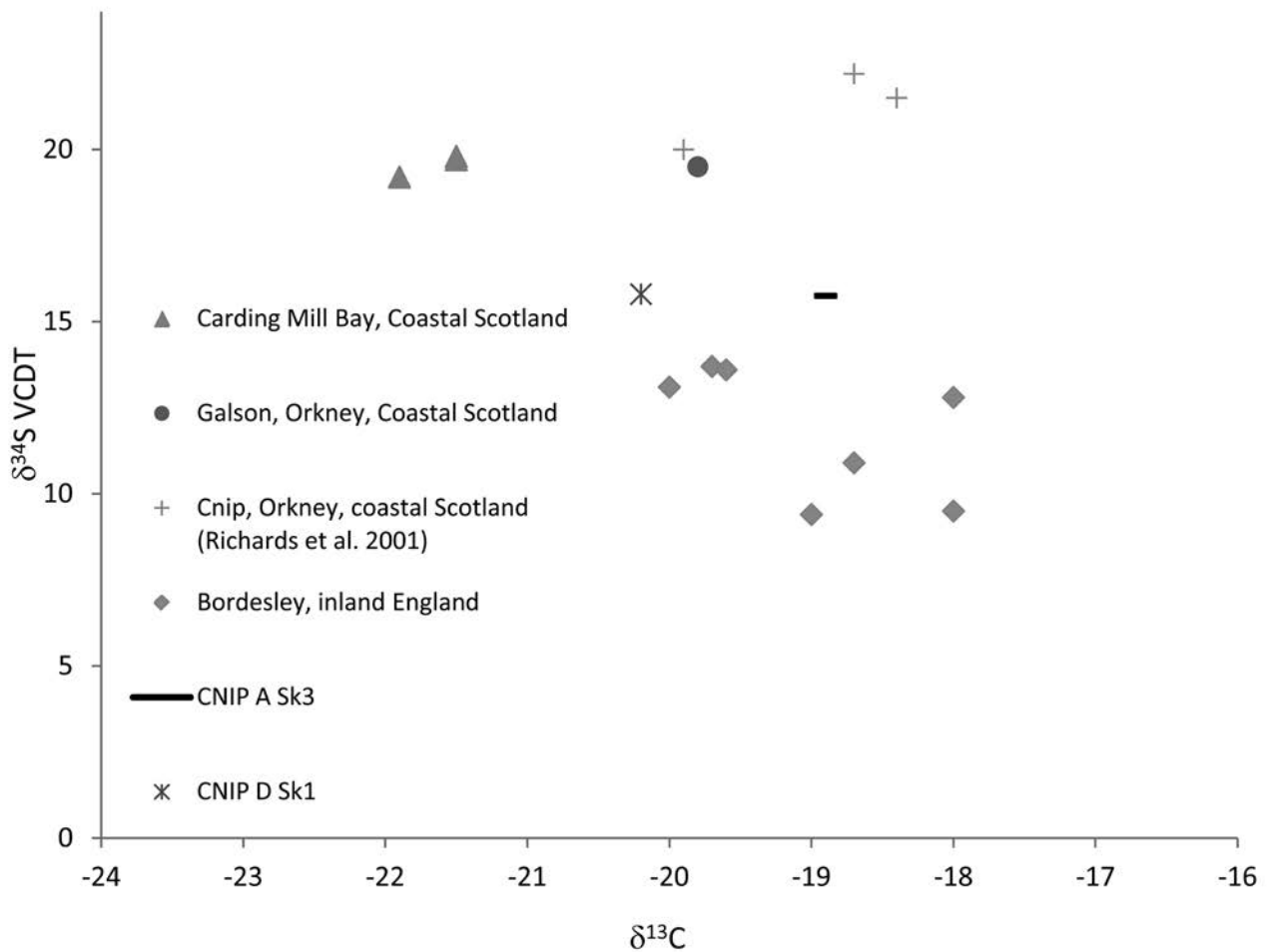

Illus 15 Comparison of sulphur data for burials at Cnip Headland with other UK archaeological data (Richards et al 2001)

an individual previously analysed from the adjacent Bronze Age burial (Dunwell et al 1995a) and all but two of the individuals from the Norse-period cemetery (Dunwell et al 1995b), and like them were probably native to the area (Richards et al 2001).

Although this analysis did not extend to the whole burial population, it has established the likely origins of two of the individuals interred at the site. The stable isotope signatures in the bones and teeth of Sk 1 and Sk 2 indicate that they most

likely grew up in the Outer Hebrides and that their diets consisted of both animal and marine protein.

5.2.4 Bone histology analysis

Thomas Booth

The semi-articulated state of some of the human remains recovered from Cnip Headland raised the possibility that intervals had occurred between death and interment, during which some or all of the soft tissue had decayed. In order to clarify this, analysis

of the bone histology (or microscopic anatomy) was carried out to establish the degree of microbial attack. The two major factors that affect bone microstructure are the burial environment and pre-burial taphonomy (Smith et al 2007). A selection of human remains recovered from Areas A, C and D was therefore analysed to assess the extent to which the bodies had been attacked by putrefactive bacteria, which escape from the viscera and exploit the bone protein in the early post-mortem period, causing small tunnels or micro-foci of destruction (MFD) (Hackett 1981; Bell et al 1996; Jans et al 2004). These MFD are visible through microscopic examination of bone thin sections. Particular bones from Areas A, C and D were sampled to allow for all forms of funerary rite to be represented from each area (see Table 7).

A 1cm × 1cm section was cut from the anterior midshaft of each bone and two sections, 50–75µm thick, were produced from each bone cutting and mounted onto slides. They were examined under normal and polarised transmitted light and were quantitatively assessed, using the Oxford Histological Index (OHI), at the periosteal (outer), internal (middle) and endosteal (inner) surfaces of the thin sections to allow for variation in histological integrity (Hedges et al 1995).

All of the remains from Cnip Headland were excavated from alkaline machair sands, a benign environment for bone diagenesis (or post-mortem physico-chemical alterations). Thus, the bones should only have been affected by biogenic attack as a result of putrefaction (Child 1995; Jans 2008), and the microstructural preservation should reflect the extent to which post-mortem treatment allowed gut bacteria to access the bone (Nielsen-Marsh et al 2007).

The results (Table 7) indicate that the preservation of almost all of the samples was good to excellent (Median OHI = 3–5), with some variation in histological integrity between them, accompanied by a loss or reduction of collagen birefringence under polarised light. The excellent histological preservation of bone from Areas A and C indicates that their respective funerary treatments prevented intestinal bacteria from accessing the bone in the early post-mortem period. Most of the thin sections displayed pre-tunnelling, a precursor to MFD (White 2009), indicating that the human

remains from both areas were probably affected by the earliest stages of bacterial diagenesis. The only exception was the sample from Sk 2, the female adult in Area D, on which the bone microstructure was completely degraded (Illus 16). Detailed examination of the Sk 2 thin sections revealed MFD in the form of tunnelling and hypermineralised cuffs (Hackett 1981: 250), with a 20µm-wide sliver of well-preserved bone (OHI = 4) at the inner surface.

Two of the Area C samples (a right radius and left femur, SF19 and SF50 respectively) displayed brown humic staining that was probably caused by the brown sand in which the remains were interred (Lelong 2009). Although the staining embellished the microstructural damage, it is likely that these two bones retain the same level of histological preservation as the other samples from Areas A and C. The most probable cause of the abundant microfissures observed in the Area C right femur (SF20) and the Sk 1 humerus is natural sediment movement and erosion (Smith et al 2002; Guarino et al 2006; Hanson & Cain 2007).

The limited biogenic attack evident in the bones from Areas A and C raises the possibility that the bodies were dismembered (Nielsen-Marsh et al 2007), involving the removal of the limbs from the trunk and hence from the gut at a very early stage. Although no cut marks were found on any of the bones, erosion of the cortex may have erased signs of butchery. Alternatively, the histological pattern of the disarticulated remains could be explained by surface exposure. When a body is left to rot above ground, skeletonisation and putrefaction occur much more quickly than when remains are buried (Simmons et al 2010). Subsequently, exposed remains demonstrate lower levels of histological destruction than inhumed bodies, as the gut microflora have not had as much time to multiply and colonise the bone (White 2009).

A scenario in which at least some of the bodies were left exposed and then retrieved is supported by the presence of partial articulation, for example in Sk 1 and some of the limbs in Area C, although in Area C there were also indications of skeletal reassembly and complete disarticulation. Carnivore marks might be expected on bones that were left exposed (Carr & Knüsel 1997; Redfern 2008) and none were evident on the Cnip Headland remains. However, any such marks could have eroded away,

Table 7 Oxford Histological Index scores of the Cnip Headland thin sections

Specimen	Area	Element	Slide	% Periosteal remaining	OHI	% Internal remaining	OHI	% Endosteal remaining	OHI	Median OHI
Sk 1	A	R femur	1	>85	4	>85	4	>95	5	4
			2	>85	4	>85	4	>95	5	4
Sk 1	A	R humerus	1	>85	4	>85	4	>85	4	4
			2	>85	4	>95	5	>95	5	5
SF54B	A	5th L metatarsal	1	>85	4	>85	4	>95	5	4
			2	>85	4	>85	4	>95	5	4
SF20	C	R femur (sub-adult)	1	>85	4	>85	4	>85	4	4
			2	>85	4	>85	4	>85	4	4
SF19	C	R radius (adult)	1	>85	4	>85	4	>85	4	4
			2	>50	3	>85	4	>50	3	3
SF50	C	L femur (sub-adult)	1	>85	4	>85	4	>85	4	4
			2	>85	4	>50	3	>50	3	3
Sk 2	D	Femur	1	>15	1	>15	1	>15	1	1
			2	>15	1	>15	1	>15	1	1
Sk 3	D	Femur	1	>85	5	>85	5	>85	5	5
			2	>85	5	>85	5	>85	5	5

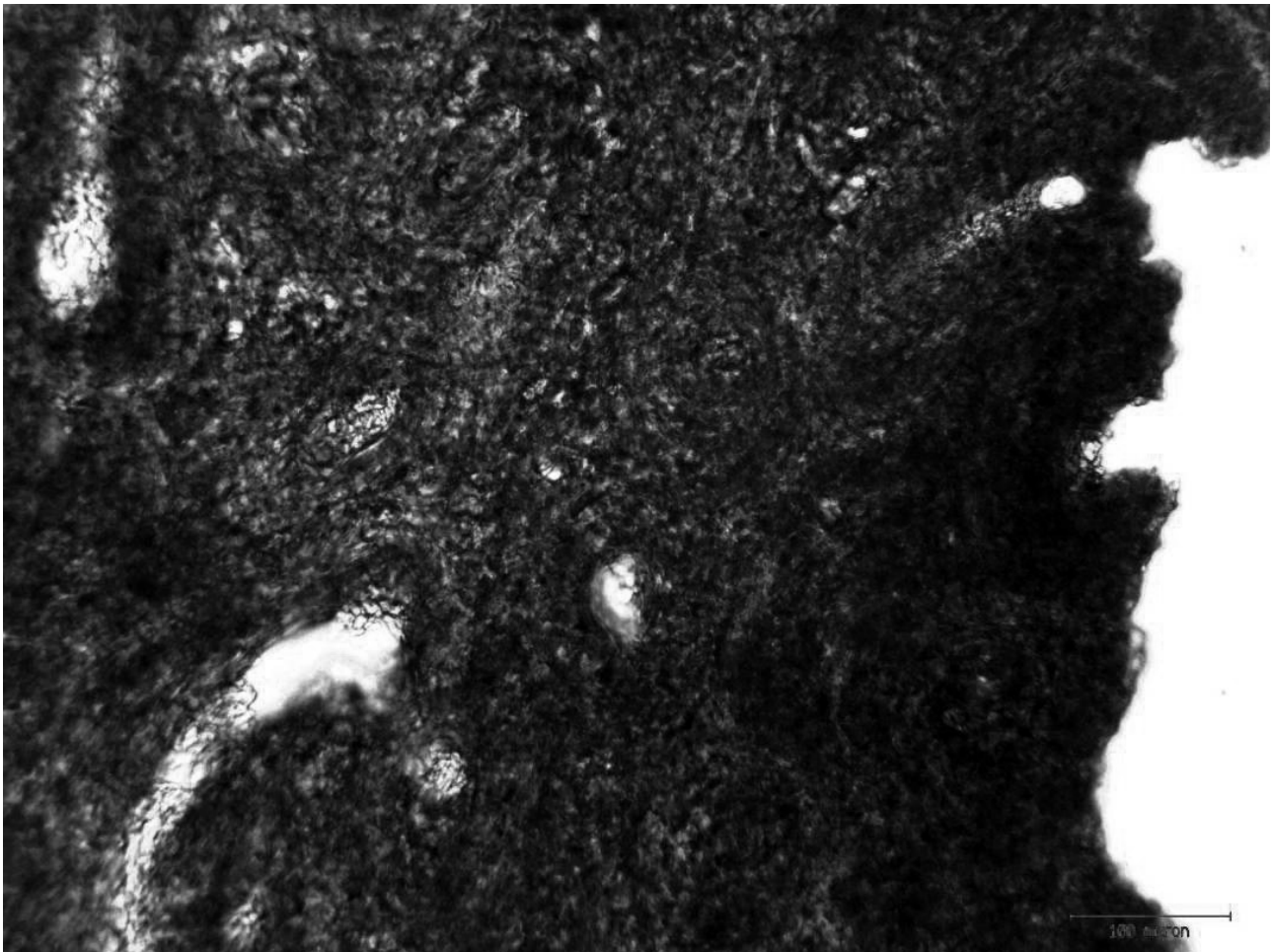

Illus 16 Periosteal surface of an Sk 2 femoral thin section, demonstrating extensive bacterial attack that has entirely consumed the bone microstructure

or the bodies may have been protected by a barrier or placed on a platform during excarnation.

The histological integrity of Sk 1 (Illus 17) was the same if not greater than that of the disarticulated remains from Areas A and C. The separation of the head, torso and lower body of Sk 1 and the displacement of several articulated vertebrae could indicate that the body was partially excarnated on the ground surface and retrieved before it had skeletonised, but after partial decay of the soft tissue. The similar microstructural organisation and preservation of the Sk 1 humeral and femoral cortical bone suggests that the bones probably came from one individual, although the outcome would have been the same had two individuals of a similar age been subjected to identical funerary rites (Kerley 1965).

The Sk 3 neonatal skeleton from Area D demonstrated perfect microstructural preservation

despite remaining fully articulated. This pattern would be paradoxical if observed on an adult individual, but it is consistent with what would be expected from the articulated inhumation of a stillborn neonate (Jans et al 2004; Nielsen-Marsh et al 2007; White 2009). Human babies are born sterile and only begin to develop gut bacteria in the first few days after birth (Tannock 1995; Mackie et al 1999), so the bones of stillborn neonate remains should demonstrate limited or no bioerosion in their internal microstructure (White 2009).

The poor microstructural bone preservation in Sk 2 is puzzling, as the body's partial articulation and the presence of only one lower limb suggests that its treatment was similar to the Sk 1 remains. In fact, its preservation is most consistent with the patterns of diagenetic attack seen on bones from articulated adult bodies that were buried soon after death (Jans

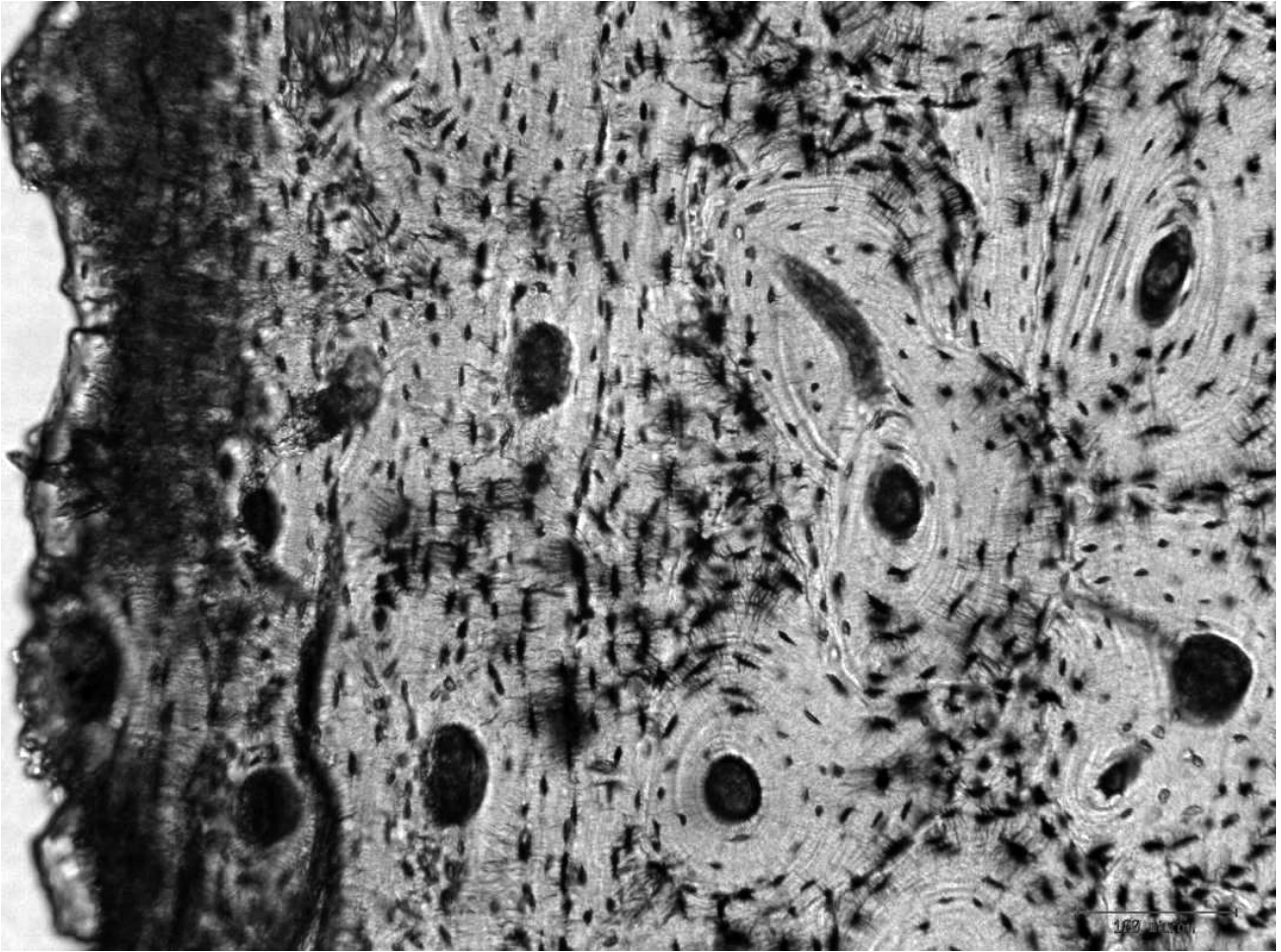

Illus 17 Periosteal surface of the Sk1 left femoral thin section, demonstrating excellent histological preservation with some enlarged osteocyte lacunae and pre-tunnelling

et al 2004; Nielsen-Marsh et al 2007; White 2009). One possible explanation is that Sk 2 was buried first in an environment that encouraged microstructural decay (Smith et al 2007), and reburied in Area D before the body had skeletonised. However, it would have taken much longer for the remains to become partially disarticulated underground than if they had been exposed on the surface (Simmons et al 2010), so in that scenario the duration of the primary burial would have been longer than for Sk 1.

In conclusion, the most elegant explanation for the distribution of histological preservation among the bone samples from Cnip Headland is that all but two of the individuals were exhumed by exposure above ground, then reburied close to the cairn. The stillborn Sk 3 was buried in Area D immediately after death, while Sk 2 was buried first elsewhere and then reburied above Sk 3. The rite of surface exhumation could be subdivided by the

extent to which the remains were allowed to decay, whether it was to the point of partial or complete disarticulation.

5.3 Radiocarbon dates and Bayesian analysis

Derek Hamilton

Fifteen ^{14}C measurements were obtained from the human bone excavated on Cnip Headland in 2009–10, with a further two available from earlier investigations at the site (see Table 8). Of the previously dated material, a carbonised residue/concretion, originally adhering to the interior wall of the urn in the corbelled cist of the cairn, was radiocarbon-dated (GU-1174) in 1979 (Close-Brooks 1995), while the femur and tibia of an adult male were dated (GU-3488) from a burial excavated in 1993 (Dunwell et al 1995a). The results are presented together here and analysed using a Bayesian approach to provide a more

Table 8 Radiocarbon results from Cnip Headland. (The calibrated result given here is based on the assumption that the individuals had a 100% terrestrial diet. The stable isotopes for these samples, however, suggest a marine component to the diet. These results have been adjusted for the marine component and recalibrated in Table 9 using a mixture of the terrestrial and marine radiocarbon calibration curves.)

Lab ID [Burial ID]	Material	Area and context	Description of depositional context	Uncal	Calibrated 1 sigma (68.2%)	Calibrated 2 sigma (95.4%)	δC^{13}	Posterior density estimate (95% probability)
SUERC- 30853 [Sk 1]	Human bone: left rib	A – 5	Main burial; secondary deposit after partial excarnation	3435±35	1870–1680 BC	1880–1640 BC	-19.4	1745–1655 BC
SUERC- 30858 [SF61]	Human bone: left fibula	A – 12	Disarticulated remains; possibly part of Sk 1; secondary deposit after excarnation	3430±35	1870–1680 BC	1880–1630 BC	-19.2	1745–1655 BC
SUERC- 30854 [SF62]	Human bone: left talus	A – 5	Human remains with Sk 1 vertebrae; secondary deposit	3410±35	1750–1640 BC	1870–1620 BC	-19.3	1745–1650 BC
SUERC- 30859 [SF54B]	Human bone: 5th left foot metatarsal	A – 14	In packing sand in stone setting; secondary deposit	3430±35	1870–1680 BC	1880–1630 BC	-19.8	1745–1660 BC
GU-1174	Carbonised residue, originally adhering to walls of urn (original sample = 40g)		Urn in corbelled cist in cairn; primary deposit (Close- Brooks 1995)	3410±55		1883–1537 BC	-26.5	1750–1655 BC
SUERC- 30860 [SF54A]	Human bone: 4th left hand metacarpal	A – 14	In packing sand in stone setting; secondary deposit after excarnation	3335±35	1690–1530 BC	1740–1520 BC	-19.7	1750–1670 BC
SUERC- 30861 [SF18B]	Human bone: C2 vertebra	C – 25 Cluster 1	In sand deposit in kerbed mound; secondary deposit after excarnation	3480±35	1880–1740 BC	1900–1690 BC	-19.1	1750–1685 BC
SUERC- 30862 [SF18A]	Human bone: C2 vertebra	C – 25 Cluster 1	In sand deposit in kerbed mound; secondary deposit after excarnation	3465±35	1880–1730 BC	1890–1680 BC	-18.9	1750–1685 BC

Table 8 *cont.*

Lab ID [Burial ID]	Material	Area and context	Description of depositional context	Uncal	Calibrated 1 sigma (68.2%)	Calibrated 2 sigma (95.4%)	δC^{13}	Posterior density estimate (95% probability)
SUERC- 30863 [SF17]	Human bone: infant zygomatic	C – 25 Cluster 1	In sand deposit in kerbed mound; secondary deposit after exarnation	3425±35	1870–1680 BC	1880–1630 BC	-19.0	1745–1685 BC
SUERC- 30864	Human bone: left proximal tibia epiphysis (SF16)	C – 25 Cluster 1	In sand deposit in kerbed mound; secondary deposit after exarnation	3455±35	1880–1690 BC	1890–1680 BC	-20.0	1755–1685 BC
SUERC- 30868	Human bone: right innominate (SF40)	C – 17 Cluster 3	In sand deposit in kerbed mound; secondary deposit after exarnation	3410±35	1750–1640 BC	1870–1620 BC	-18.9	1735–1650 BC
SUERC- 30869	Human bone: left innominate (SF26)	C – 17 Cluster 2	In sand deposit in kerbed mound; secondary deposit after exarnation	3440±35	1870–1680 BC	1890–1660 BC	-19.9	1735–1655 BC
SUERC- 30870	Human bone: infant petrous (SF25)	C – 17 Cluster 2	In sand deposit in kerbed mound; secondary deposit after exarnation	3500±35	1890–1770 BC	1930–1700 BC	-19.3	1735–1660 BC
SUERC- 30871	Human bone: tibia shaft (SF32)	C – 17 Cluster 2	In sand deposit in kerbed mound; secondary deposit after exarnation	3450±35	1880–1690 BC	1890–1680 BC	-20.0	1735–1665 BC
SUERC- 30872	Human bone: femur shaft fragment (Sk 3)	D – 103	Main burial in pit; secondary deposit after partial exarnation	3375±35	1740–1620 BC	1750–1530 BC	-20.2	1740–1645 BC
SUERC- 30873	Human bone: infant femur (Sk 3)	D – 108	Main burial in pit; primary deposit	3440±35	1870–1680 BC	1890–1660 BC	-19.7	1750–1675 BC
GU-3488	Human bone: femur and tibia	N/A	Primary burial (Dunwell 1995a)	3360±50		1768–1517 BC	-20.7	1745–1650 BC

precise and robust chronology for the sequence of Bronze Age activity (Buck et al 1996).

Although the simple calibrated dates are accurate estimates of the dates of the samples, this is usually not what archaeologists really wish to know; instead, it is the dates of the archaeological events represented by those samples which are of interest. In the case of Cnip Headland, the most important issue is the overall chronology of the use of the area for burial – when it began and how long it continued – rather than the dates of individual samples. The dates of this activity can be estimated not only using absolute dating information from the radiocarbon

measurements on the samples, but also by using the stratigraphic relationships between samples.

Methodology is now available which allows the combination of these different types of information explicitly, to produce realistic estimates of the dates of archaeological interest. It should be emphasised that the *posterior density estimates* produced by this modelling (see Table 8) are not absolute. They are interpretative *estimates*, which can and will change as further data become available and as other researchers choose to model the existing data from different perspectives. The technique used is a form of Markov Chain Monte Carlo sampling, and

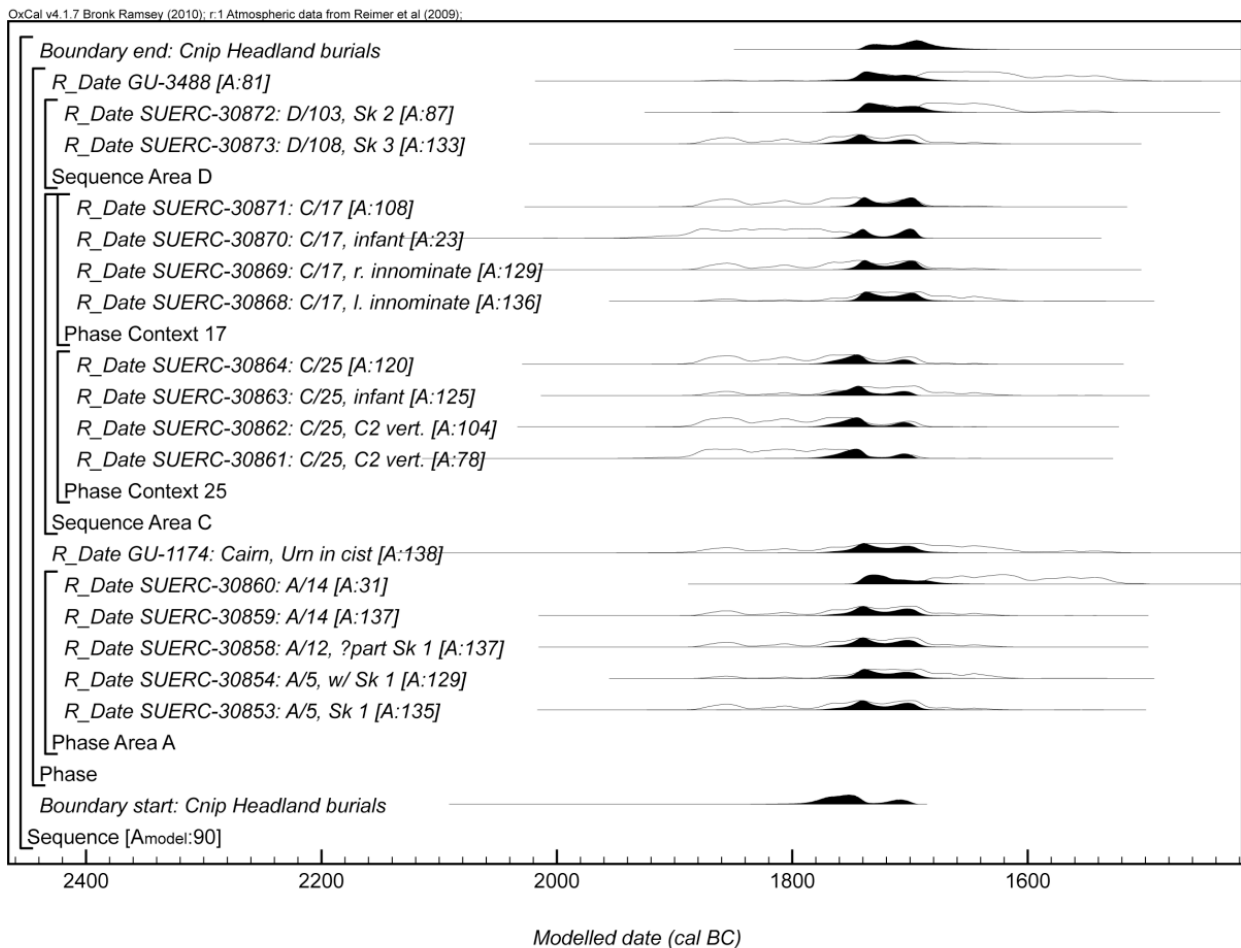

Illus 18 Chronological model for the Bronze Age burials at Cnip Headland

Note. Each distribution represents the relative probability that an event occurred at some particular time. For each of the radiocarbon measurements two distributions have been plotted, one in outline, which is the result of simple radiocarbon calibration, and a solid one, which is based on the chronological model use. The other distributions correspond to aspects of the model. For example, ‘start: Cnip Headland burials’ is the estimated date that activity began at this site, based on the radiocarbon dating results. The large square braces along with the OxCal keywords define the overall model exactly.

has been applied using the program OxCal v4.1. Details of the algorithms employed by this program are available from the online manual or in Bronk Ramsey (1995; 1998; 2001; 2009). The algorithm used in the model described below can be derived directly from the model structure shown in Illus 18.

The analysis was carried out at the Scottish Universities Environmental Research Centre (SUERC), using methods described in Stenhouse & Baxter (1983), Slota et al 1987 and Xu et al (2004) for the 2009–10 samples and in Noakes et al (1965) for the two samples submitted in 1979 and 1993. SUERC maintains rigorous internal quality assurance procedures, and international inter-comparisons (Scott 2003) indicate no laboratory offsets, thus validating the measurement precision quoted for the radiocarbon ages.

The results presented in Table 8 are conventional radiocarbon ages (Stuiver & Polach 1977), quoted according to the international standard set at the Trondheim Convention (Stuiver & Kra 1986). They have been calibrated with the internationally agreed IntCal09 atmospheric curve of Reimer et al (2009),

using OxCal v4.1 (Bronk Ramsey 1995; 1998; 2001; 2009). The date ranges have been calculated using the maximum intercept method (Stuiver & Reimer 1986), and quoted in the form recommended by Mook (1986), with the endpoints rounded outwards to ten years. The probability distributions in Illus 18 were obtained by the probability method (Stuiver & Reimer 1993).

5.3.1 Stable isotopes and marine correction

The ratios of carbon to nitrogen (C:N) for these samples suggest that bone preservation was sufficiently good to support confidence in the accuracy of the radiocarbon determinations (Masters 1987; Tuross et al 1988). The $\delta^{13}\text{C}$ and $\delta^{15}\text{N}$ values from the burials (Illus 19) suggest a very small marine component in the diet, which is not likely to affect the radiocarbon dating significantly (Chisholm et al 1982; Schoeninger et al 1983). However, in the interests of thoroughness and robustness, the radiocarbon results for the human bone were modelled for a marine offset.

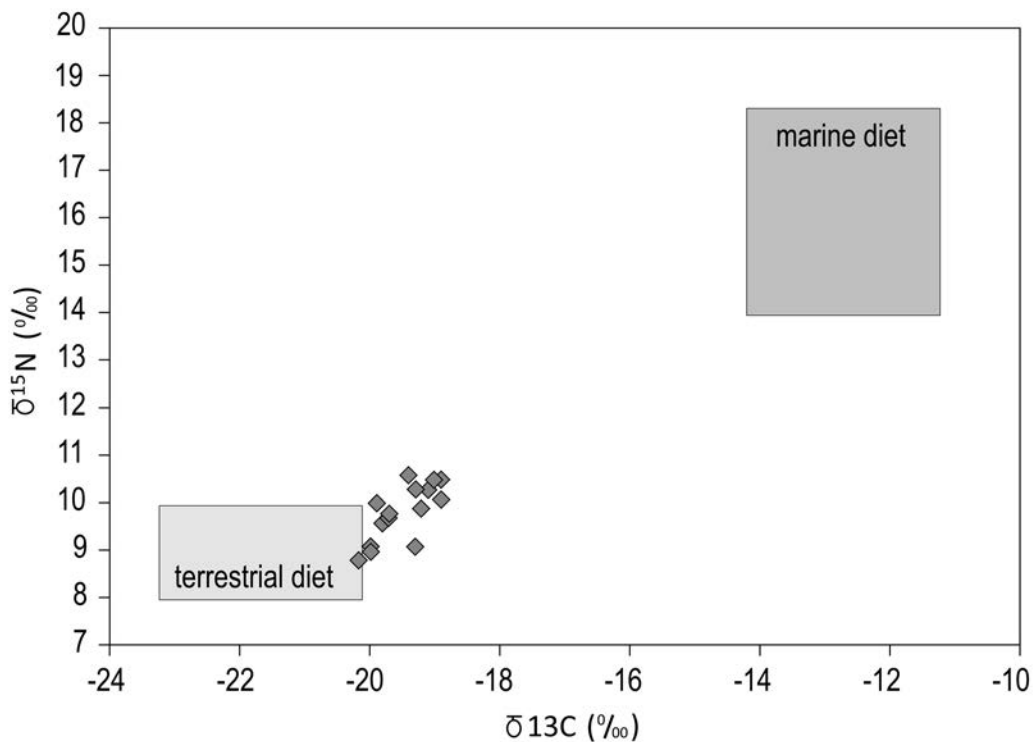

Illus 19 Plot of the stable isotope results for those human bone samples where there is both a $\delta^{13}\text{C}$ and $\delta^{15}\text{N}$ measurement available. The boxes for the expected values of fully terrestrial versus fully marine values are based on the data of Mays (1998: fig 9)

When humans and non-human animals consume marine resources, the radiocarbon age of their bones will be older than expected. This is because, while the production and distribution of radiocarbon in the atmosphere is virtually instantaneous, so that terrestrial plants and animals that feed on them have their ratio of radiocarbon in equilibrium, when ^{14}C enters the oceans it is not distributed instantaneously and instead persists for a while at some depth. As a result, the marine carbon cycle is not in synch with the terrestrial, and marine ages are too old when calibrated with the terrestrial radiocarbon calibration curve.

It is possible to correct radiocarbon ages for material whose protein has come from both terrestrial and marine sources (Bayliss et al 2004). It should be stressed that this marine correction is, in essence, a modelled radiocarbon calibration that uses a mixture of the internationally agreed calibration curves IntCal09 and Marine09 (Reimer et al 2009). It is a modelled calibration because there is more than one way to determine the percentage of diet that derived from terrestrial/marine resources. As such, the results will vary slightly depending on the method used.

The method employed here was to calculate the percentage of the diet that was terrestrial by using -12.5‰ and -20.0‰ as the end members for the

$\delta^{13}\text{C}$, where -20.0‰ was the equivalent of 100% terrestrial and -12.5‰ was equal to 100% marine. Radiocarbon results with a marine component determined to be 1% or greater were corrected using OxCal and by mixing the two calibration curves at the calculated percentage. In the absence of data that are site- and time-specific, the ΔR used was 0 ± 50 (G Cook, pers comm) and the percent marine was given a standard deviation of $\pm 10\%$. The corrected radiocarbon dates are given in Table 9, and these same corrected dates were used throughout the modelling of the results from Cnip Headland.

5.3.2 The samples and model

The burials from Cnip Headland present a few difficulties for Bayesian modelling. Firstly, nearly all of the bodies appeared to have undergone excarnation prior to burial (5.2.4 'Bone histology analysis' above). This can present a problem when interpreting the relative order of some burials that are stratigraphically related. In some cases, certain elements were articulated (for example, parts of Sk 1 in Area A), indicating that the bones were held together by some flesh, tendons and ligaments at the time of burial, but there were also many disarticulated bones. While we can feel somewhat

Table 9 Calibrated dates for radiocarbon results on samples of human bone identified as having a marine component

Lab ID [Burial ID]	Radiocarbon age (BP)	Modelled % marine	Marine-corrected calibrated date (95% confidence)
SUERC-30853 [Sk 3]	3435±35	8	1880–1600 cal BC
SUERC-30858 [SF61]	3430±35	11	1880–1530 cal BC
SUERC-30854 [SF62]	3410±35	9	1870–1530 cal BC
SUERC-30859 [SF54B]	3430±35	3	1890–1610 cal BC
SUERC-30860 [SF54A]	3335±35	4	1740–1490 cal BC
SUERC-30861 [SF18B]	3480±35	12	1890–1620 cal BC
SUERC-30862 [SF18A]	3465±35	15	1880–1610 cal BC
SUERC-30863 [SF17]	3425±35	13	1870–1530 cal BC
SUERC-30868 [SF40]	3410±35	15	1760–1520 cal BC
SUERC-30869 [SF26]	3440±35	1	1890–1620 cal BC
SUERC-30870 [SF25]	3500±35	9	1920–1680 cal BC
SUERC-30873 [Sk 2]	3440±35	4	1890–1610 cal BC

confident that the partially articulated remains were placed in the ground within a few months of death (Mant 1987), we are less certain where the disarticulated remains are concerned. Because of the fragmentary and mixed nature of some of the deposits, especially in Areas A and C, a chi-square test (Ward & Wilson 1978) has been used to test the consistency of the results and to help identify where possible outliers might occur, and also to determine if any of the disarticulated remains may be residual in their contexts.

With the exception of the two radiocarbon results from the earlier excavations, the samples from Cnip Headland can be grouped into three excavation areas (A, C and D). These cannot be stratigraphically linked to one another, nor to either of the previously dated samples. All of the five measurements from Area A, from the remains of at least two individuals, are statistically consistent with each other and so could all be the same actual age. Similarly, all eight of the measurements from at least four individuals over two contexts in Area C are statistically consistent and so could all be the same actual age. While these were two discrete episodes of burial, the chi-square

result does suggest that they were not separated by a great length of time.

5.3.3 Results

All of the radiocarbon results on Bronze Age material from Cnip Headland appear to be very similar in age. The entire suite was subjected to a chi-square test, which indicated that they are all statistically consistent. While the measurements could all be the same actual age, the test is more likely indicating that the dated activity spans a shorter rather than longer period of time. This should be kept in mind when interpreting the final set of results, as a model with a low number of dates and very little stratigraphy is likely to overestimate the span of activity (Steier & Rom 2000).

The model has good agreement between the radiocarbon dates and the parameters described above. It allows the determination of increasingly specific time ranges for the commencement and cessation of activity, accompanied by decreasing levels of probability.

The model estimates that burial activity began in 1770–1690 cal BC (95% probability), and

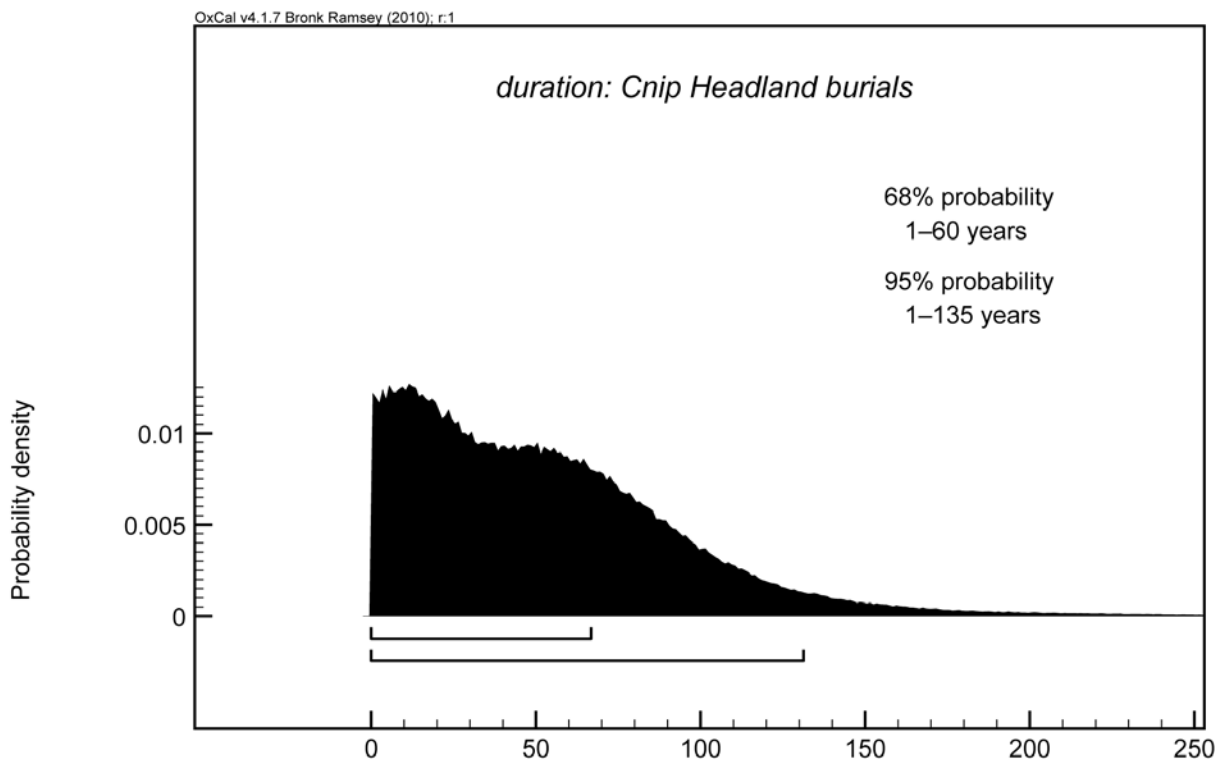

Illus 20 Span of activity associated with the radiocarbon dates from Cnip Headland

probably in 1750–1710 cal BC (68% probability). Burial activity ended in 1735–1620 cal BC (95% probability) and probably in 1725–1650 cal BC (68% probability) (see Illus 18 & 20). The dated burials thus span a period of up to 150 years (95% probability) and probably up to 100 years (68% probability).

6. ARTEFACTS WITH THE BURIALS

6.1 Worked bone in Area A

Dawn McLaren

Four fragments of animal bone (SF57–60) were found at the right side of the head of the adolescent male (Sk 1) in Area A during post-excavation analysis (Illus 21). They had been sealed beneath the cranium and had been lifted along with it during excavation.

The animal bone comprises three fragments of lower canine teeth, or tusks, from male pigs and a short, rounded maxillary tooth from a medium to medium-large mammal, tentatively identified as a juvenile seal (Andrew Kitchener & Jerry Herman, pers comm). It is not possible to confirm whether the tusks came from wild or domestic animals. Likewise, it is impossible to say with confidence whether the incomplete state and degraded condition of the tusks and seal tooth are the result of primary exposure or degradation during subsequent burial.

Only one of the fragments, a short, curving piece detached from near the tip of a tusk, has any visible sign of modification (SF58). This is in the form of a circular perforation at the widest end for suspension as an ornament or pendant. The other two tusk fragments (SF59 and SF60), which appear eroded and damaged, both came from a different tusk or tusks. Neither has any sign of deliberate modification. Interestingly, the two (or more) tusks represented by SF58, SF59 and SF60 are from the left side of the jaw, indicating that they are from at least two separate animals. Male pig lower canines such as these are three-sided in section, but the fragments from Cnip Headland preserve only one surface from each tusk.

The possible seal's tooth (SF57) has no sign of deliberate modification. The root of the tooth is missing and the tip is abraded, resulting in the

exposure of the irregular, linear nerve channel which runs through the interior. This natural feature might have been used to string the tooth for use as a bead, but the channel is so narrow that this may not have been possible.

Although not common, the association of boars' tusks with funerary contexts in Britain is known to span a wide chronological period, from the Early Neolithic through to the Beaker/Chalcolithic and Early Bronze Age. Prior to a recent study of this artefact type by Woodward & Hunter (2015: 141–5), no detailed consideration of modified or unmodified tusks and teeth in Beaker and Early Bronze Age graves had been published, although the significance of Neolithic examples has been previously discussed (Kinnes 1979: 69, figs 3.2–3, 18.5 and 18.9; Kinnes et al 1983: 87–90; Gibson 2012).

Woodward & Hunter's study focused on 36 wild and domestic pigs' tusks from Neolithic, Beaker and Early Bronze Age burials in Cumbria, Derbyshire, Gloucestershire, Wiltshire and Yorkshire (Woodward & Hunter 2015: table 5.1.1). To the list of Beaker/EBA tusks they examined we can add further examples, such as those from the Boscombe Bowmen grave, Amesbury and Sutton Veny, 11a, both Wiltshire (Fitzpatrick 2011: 17, 61); Pershore, Worcestershire (Smith 1957: 20, fig 7:1, Clarke 1970: 505, no. 1209), and a grave at Deeping St Nicholas, Lincolnshire (French 1994).

Apart from the Cnip Headland tusk fragments, only two possible tusk finds have previously been recorded in Scotland – from Rathen, Aberdeenshire and Letham, Perth & Kinross. The Rathen example is a substantial tusk which was reported in the mid 1800s to have been found in a large, unornamented cinerary urn (*Proc Soc Antiq Scot* 3 (1857–9: 439); NMS: X.EA 74). It shows no sign of modification or exposure to fire, and apparent polishing towards the tip is entirely natural. Another possible boar's tusk from an Early Bronze Age short cist at Letham, Perth & Kinross is recorded in the archives of National Museums Scotland (unpublished; NMS: X.EQ 242). Re-examination of this object by the writer confirms that it was previously misidentified and is actually a calcined bone pin rather than a tusk.

Unmodified tusks, such as those from Rathen, Aberdeenshire and Wilsford G58, Wiltshire

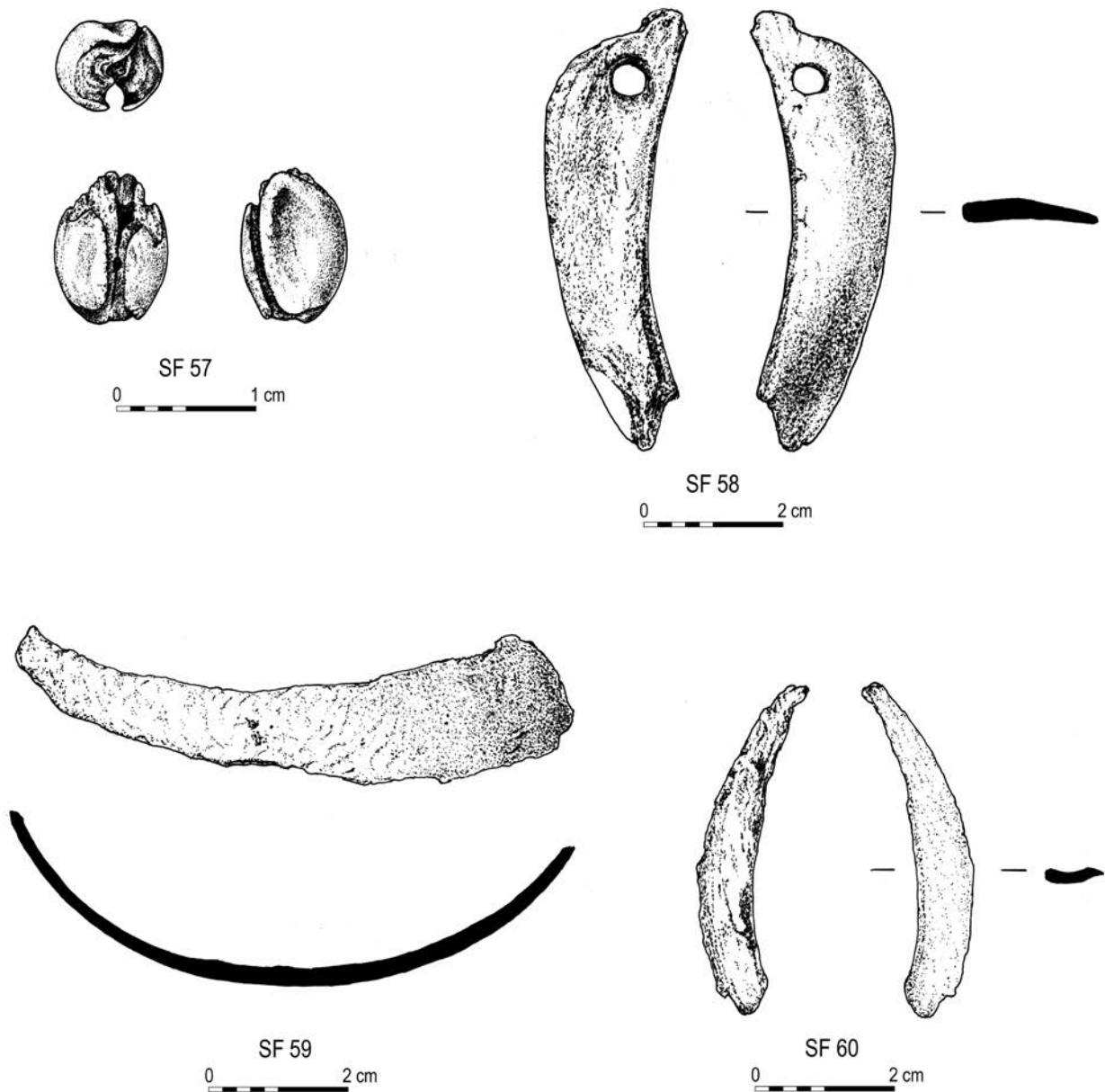

Illus 21 Worked bone/ivory from Area A

(Annable & Simpson 1964: 48, 102, no. 215; Woodward & Hunter 2015: 142, fig 5.1.1, ID 924), tend to be of impressive proportions. In the past, they have generally been interpreted as points and tools, metalworking implements, ornaments and hunting trophies (Woodward et al 2005: 45; Fitzpatrick 2011: 61). Caution has been recently urged, however, regarding their interpretation as tools; the damage which was previously interpreted as resulting from deliberate use is likely instead to be natural wear, incurred by the animal during life

(Woodward et al 2005: 45; Woodward & Hunter 2015: 141, 143). Recent re-analysis of these objects has suggested that the tusks (both modified and unmodified) were principally ornamental, both in the Neolithic and Beaker/Early Bronze Age periods (Woodward & Hunter 2015: 143). A recent study of grave goods from Chalcolithic and Early Bronze Age female burials in Britain has recognised an association between young adults and pig bones in funerary contexts (Rogers 2013: 35). The motivations that underpin this association are not

transparent. However, it has been suggested that, as pig bones were seldom transformed into artefacts in the early prehistoric period yet feature regularly in deposits of feasting debris, pigs were considered to have special ritual and symbolic importance (Woodward & Hunter 2015: 145).

Tusks from only four Beaker/Early Bronze Age burials examined by Woodward & Hunter (2015) were perforated like SF58 from Cnip Headland (ibid: 143). These include tusks from Folkton 70, burial 13, Yorkshire (Greenwell & Rolleston 1877: 466; Kinnes & Longworth 1985: 78); Upton Lovell G2a, Wiltshire (Hoare 1812: 202–5, pls xxvi, xxvii; Piggott 1938: 105; Annable & Simpson 1964: 22–3); Goodmanham 117, burial 1, E Yorkshire (Greenwell & Rolleston 1877: 470; Kinnes & Longworth 1985: 88), and Wilsford G1, Wiltshire (Hoare 1812: 210, pl xxx; Grinsell 1957). The perforated examples must have been worn suspended as a pendant or bead, or else sewn onto the garments of the deceased, as has been suggested for the tusks and perforated bone points associated with the Upton Lovell G2a (II) grave (Piggott 1962: 93). An example from Langton, Yorkshire (Greenwell 1865; Kinnes & Longworth 1985: 32) has been modified by a series of four incised grooves near the proximal end which may have been used to bind or sew the tusk in place (Woodward & Hunter 2015: 143).

Since most of the larger examples, such as that from Rathen, Aberdeenshire, have little evidence of modification or practical function, their importance and significance appear to lie in the material itself and its connection to the animal. As such, the idea of their inclusion within the grave as hunting trophies is a popular one. These impressive objects may have been considered to be imbued with the strength and power of the animal, a symbol of human dominance and control over nature, or a sign of a hunter's prowess, either real or imagined.

The Cnip Headland tusks are somewhat different, both in terms of size and quality. At least one was perforated, apparently designed to be worn on the body or possibly displayed, and may have been suspended as a bead or pendant or sewn on to a garment or head covering. When this function as an ornament is combined with the material's potential symbolism, it seems likely that

the Cnip tusk fragments were worn as amulets. In this way, the perforated tusk fragment with Sk 1 may be more comparable to the perforated canine tooth necklace from Skara Brae, Orkney (Clarke et al 1985: fig 3.29) than to the boars' tusks of Wessex and Yorkshire. Although the original form of the other tusk fragments from Cnip is unknown, it is likely that they, and possibly also the mammal tooth, were worn by the individual for their amuletic properties.

The use of amulets, curated objects and possible relics is becoming a more widely recognised facet of Beaker and Early Bronze Age funerary practice (Sheridan & Davis 2002; Woodward 2002; Woodward et al 2005; McLaren forthcoming). It is not possible to rehearse here at length the morphology and significance of this wide-ranging and variable group of artefacts, but several pertinent examples incorporating animal bones are worthy of specific mention. These include an unmodified pig's tusk from a Beaker grave group at Raunds Barrow 1, Northamptonshire, which radiocarbon dating demonstrated was several hundred years old at the time of burial, raising the possibility that it was a valued heirloom or ancestral relic (Healy & Harding 2004; Harding & Healy 2007; Woodward & Hunter 2015: 141). Recent re-examination of the grave goods associated with the log-coffin burial of Gristhorpe Man identified a single metatarsal from a fox and phalanges from a pine marten. This seems to indicate that he was buried with fox and pine marten pelts or with their detached paws, which are considered to be amulets (Sheridan et al 2013: 159).

Although both interpretations are equally valid, the latter view can be compared closely to the talons of a golden eagle (*Aquila chrysaetos*) recovered from a mixed deposit of cremated human bone, dominated by the remains of a nine-year-old child, at Skilmafilly, Aberdeenshire (Smith 2012: 30, illus 17). The eagle talons had been heat-affected, showing that they had been burnt on the pyre with the deceased, but were otherwise unmodified. They were found beside a second phalange of the bird's foot, as if a whole or partial foot had been present rather than disarticulated talons. If the talons formed part of a necklace or other personal ornament, they may still have been encased in the horny outer sheath of the claw (Smith 2012: 30).

These talons were initially interpreted as symbols of the power of the dead person with whom they were buried, as a sign of his or her prowess as a falconer or to demonstrate a bond with a falconer's family (ibid: 31). An alternative view is that the talons at Skilmafilly were worn in life, or gifted to the child in death, because of the perceived totemic significance of the bird – not only projecting the eagle's power, but harnessing it as a charm or amulet to protect the child from sickness and danger, either in life or in the afterlife (McLaren forthcoming).

A similar intent may be argued for the Cnip Headland tusks and tooth. Their close association with the partially articulated body of the adolescent male demonstrates that those who retrieved the corpse for burial and conducted the mortuary rites recognised their value and significance to the deceased, and reinforces the possibility that these objects were more than simple ornaments.

6.1.1 Catalogue

- ▶ SF57 Fragment of abraded animal tooth, perhaps a juvenile seal. No evidence of deliberate modification. L: 11mm; W: 8mm; Th: 6.5mm. Context 005.
- ▶ SF58 Short, thin, curved, tapering fragment from tip of boar's tusk with off-set perforation (Diam: 3.5mm) at corner of widest end. Only one surface of the original tusk is present; the extreme tip has been lost. The curved edges are fairly smooth but lack tool marks to indicate deliberate shaping. The keratinous external surface of the tusk has a high sheen, likely to be natural. L: 61.5mm; W: 10–17mm; Th: 3.8–5.3mm. Context 005.
- ▶ SF59 Thin, curved, tapering fragment of boar's tusk, broken at both ends and edges. Only one surface of the original tusk is present, with a light sheen which is likely to be natural. No evidence of deliberate modification remaining. L: 79.5mm; W: 5.5–18mm; Th: 2–2.5mm. Context 005.
- ▶ SF60 Small, thin, unmodified curved splinter of boar's tusk; no original edges remaining. It is likely that this is a further fragment of SF59 but no clear joins are present. L: 47mm; W: 3–8mm; Th 2.5mm. Context 005.

6.2 Artefacts with the human remains in Area C

Alison Sheridan

Three artefacts were found in Area C, all associated with the clusters of human remains. A bronze awl (SF14) was found in Cluster 1 in Context 25. A fusiform jet bead (SF15) was found beside the sacrum of an adult female in Cluster 3, Context 17. In Cluster 2 in the same context, under a sub-adult femur, was a chunky rectangular-section bead (SF23) of the same material.

6.2.1 The awl (SF14)

L: 66mm; max W: 4mm; bronze, in good condition. The awl is single-pointed, with a circular section towards its tip and a squarish section around the mid-point of its shaft (Illus 22). It broadens to a spatulate end, which would have constituted a tang; when in use, this end would have been hidden within the awl's organic handle.

Compositional analysis, undertaken by Dr Susanna Kirk of National Museums Scotland (NMS) using X-ray fluorescence spectrometry, confirmed that the material is bronze.

Like their bone counterparts, metal awls are known from Chalcolithic and Early Bronze Age contexts in Britain and Ireland, and have been studied by Nicholas Thomas (1968; 2005). Among their possible uses, the piercing of hide (principally to make clothes and containers) would seem to be the most probable main function – notwithstanding Thomas's concern that some seem rather delicate for such a use. The Cnip awl – like any metal object during the late 3rd and early 2nd millennium BC in the Hebrides and north-west Scottish mainland (Coles 1969) – would have constituted a precious possession, given the scarcity of metal in this part of Scotland and, with the jet jewellery (6.2.5 'Discussion of the beads' below), testifies to widespread networks of communication and trade in Early Bronze Age northern Britain.

Metal awls are mostly found in funerary contexts, where they tend to be associated with females (as discussed, for example, by Thomas 2005 and Rogers 2013), but one was found in a domestic context at Sligeanach, South Uist (Sharples & Sheridan 2012). In northern Britain,

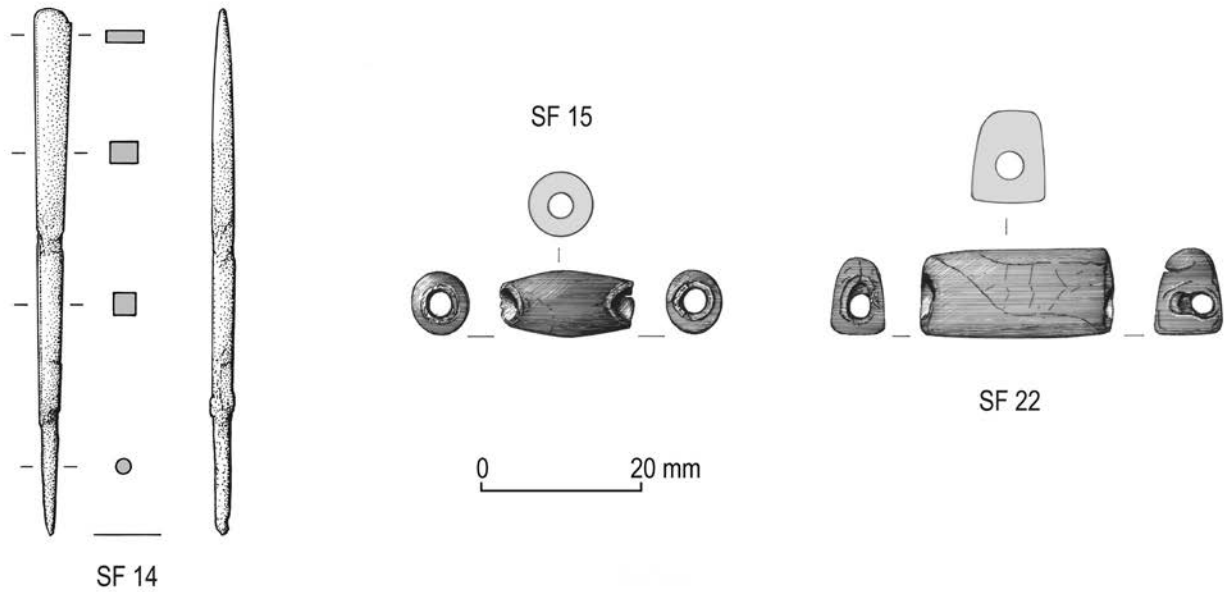

Illus 22 The copper alloy awl and jet beads from Area C (drawn by Marion O'Neil)

the main period of currency for bronze awls appears to lie between the 22nd and 19th centuries BC, to judge from radiocarbon-dated examples and from the fact that the principal ceramic association is with Food Vessel pottery (Simpson 1968; Sheridan 2004). Indeed, the Sligeanach example, though found in ploughsoil, is likely to belong to the Food Vessel-associated phase of activities at that site, radiocarbon-dated to *c* 2200–1900 cal BC (Sheridan 2012a: 231). The modelled radiocarbon dates for the human bones (5.3 'Radiocarbon dates and Bayesian analysis' above) would suggest the Cnip awl was deposited slightly later, probably during the 17th or 18th century BC.

6.2.2 Fusiform jet bead (SF15)

L: 17.5mm; Diam: 8mm; Perforation diam *c* 3mm. The fusiform bead is circular in cross-section at its widest point and has angled ends, their slope due partly to the ancient loss of material around the perforation at either end (Illus 22 & 23). Almost all the surface has been polished to a high sheen, and where the sheen is less intense (on one side, at the broadest point), there are very faint traces of multi-directional striations that relate to the shaping of the bead by abrasion.

The damage at either end consists of the loss of most of the circumference. That this occurred in

antiquity is clear from the fact that the fracture edges are worn smooth, and it probably resulted from a combination of thread pull and bead-on-bead wear (which indicates that the bead had formerly been a component in a multi-bead necklace). The areas of loss are nearly, but not quite, aligned with each other. The longitudinal, centrally positioned perforation was probably drilled from either end. Its interior is fairly smooth, and where the original ends of the perforation survive, they have been worn smooth by the thread. There are a few faint and ancient superficial scratches, and tiny chips are missing from near each end, again representing ancient damage. The overall impression is that this was an old and worn bead when buried; the nature of its parent necklace will be discussed below.

The bead is of black, compact material, warm to the touch, and over part of the surface there are superficial cracks, one oval, the others in a criss-cross shape. Macro- and microscopically it appears to be of jet. This was tested by analysing its composition using X-ray fluorescence spectrometry (XRF) at NMS and comparing it with a reference sample of Whitby jet; the analysis was undertaken by Dr Susanna Kirk. The results reveal that the bead lacks the high zirconium content of the Whitby jet sample, even though in other respects there is a reasonable match. (The bead has high calcium



Illus 23 Photographs of the fusiform jet bead SF15, showing (left) faint grinding striations across the bead's mid-point and (right) ancient damage to one end (© Alison Sheridan/NMS)

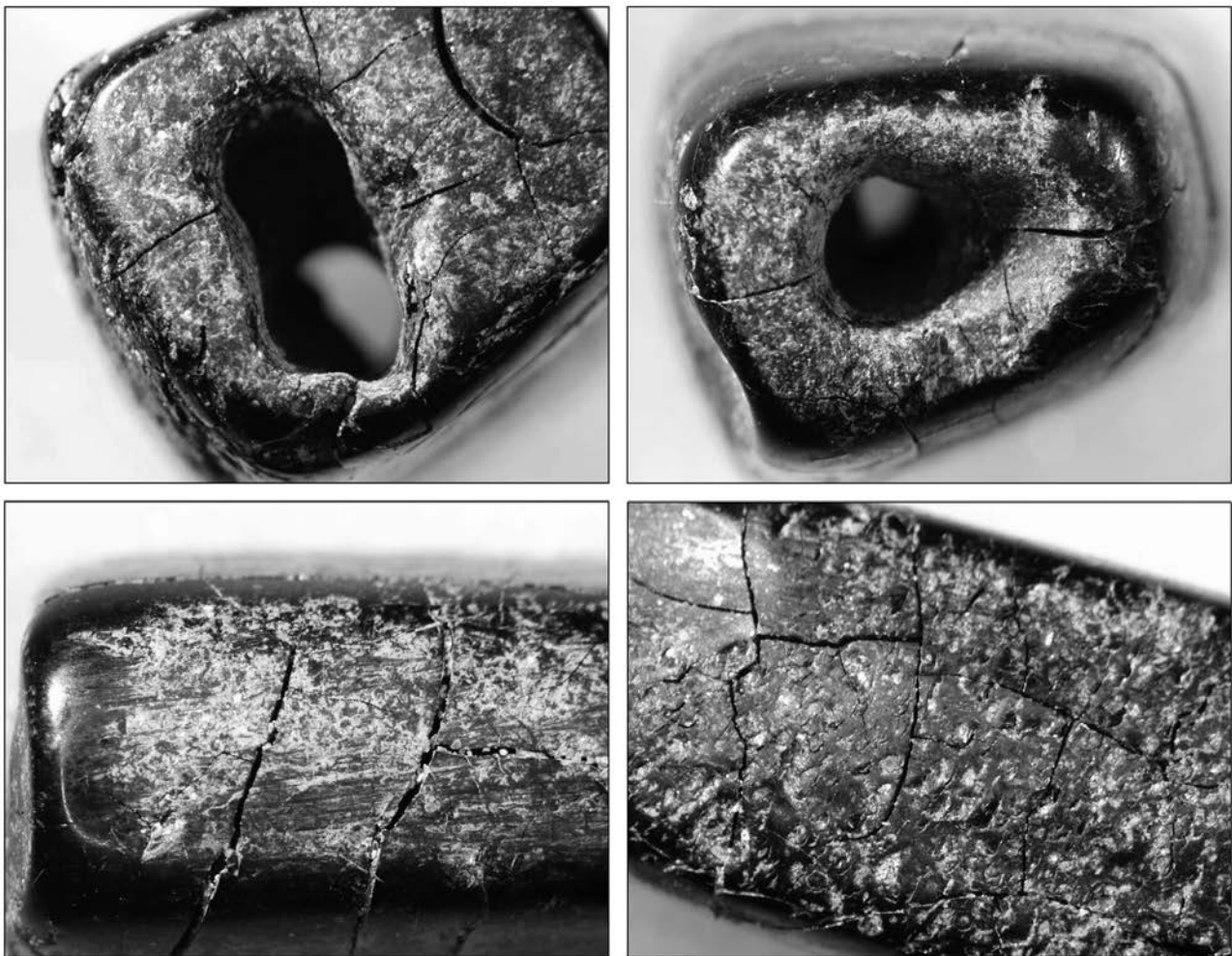

Illus 24 Photographs of the chunky jet bead SF23. Top left: end with double borehole where drill had been repositioned; top right: end with single borehole; bottom left: side showing longitudinal grinding striations; bottom right: 'orange peel' surface (© Alison Sheridan/NMS)

content, resulting from its close contact with the human bone, and its nickel content probably relates to contamination from the sand which surrounded it and filled its perforation.) The fact that it is not high in iron confirms what is already clear from macro- and microscopic examination – that the bead is not of cannel coal or shale. The low zirconium reading does not negate its identification as jet, since the zirconium content in jet can be variable. Although a source of true jet is known on Skye, there is no evidence that it was used in prehistory and, given that the bead is likely to have belonged previously to a spacer plate necklace (see below), it seems most likely that it was made, along with the rest of the original parent necklace, in the area around Whitby in North Yorkshire, some 600km to the south-east as the crow flies.

6.2.3 Chunky jet bead (SF23)

L: 24.8mm; W: 11.8mm; Th: 9.7mm; Perforation diam (interior) *c* 2.8mm, expanding to 4.2 × 2.6mm at one end.

The chunky bead is roughly rectangular, both in plan and cross-section, with one squared-off end and one partly squared-off end (Illus 22 & 24). It has a longitudinal perforation, drilled from both ends. At one end the borehole appears double and the second perforation extends only part of the way into the bead; this attests to the initial mis-positioning of the drill. Insofar as can be seen, the interior of the continuous perforation is fairly smooth. The bead's two broadest sides have been polished to a high sheen, obliterating virtually all traces of the grinding striations that had resulted from its shaping, while one of the narrow sides has just been polished to a low to medium sheen, insufficient to remove the faint traces of numerous longitudinal grinding striations. The other narrow edge has a pocked, 'orange peel'-like appearance, with a large, natural, oval dimple near one end (see below.) An attempt has been made to polish this surface, but with little success. All of one end, and most of the other, is matte.

There are signs of thread-wear: the edges of the perforations are worn smooth, and at either end there is a possible thread-groove. The bead is not damaged through wear like the fusiform bead, but it nevertheless saw enough use for the thread to

have hollowed a groove at each end.

The material used to make this bead is identical to that used for the fusiform bead (that is, jet), and it has the characteristic criss-cross surface cracking that tends to be found mostly (but not exclusively) on soft jet. The 'orange peel' surface and its oval hollow are naturally occurring features in jet, and it is possible – though hard to prove – that the parent material was a water-rolled beach pebble from the Whitby area.

There are no close parallels for this shape of bead in Early Bronze Age Scotland. The closest (and admittedly not very close) parallels are a set of four burnt bone beads – thought to be made from human finger bones – found in a cist at Patrickholm Sand Quarry, Lanarkshire (Maxwell 1949: pl 36.2). The resemblance in form is not sufficiently strong to indicate any links with these beads, however. Further afield, square-sectioned Early Bronze Age jet beads are known from Yorkshire (for example, Egton: Kinnes & Longworth 1985: 89, no. 124, burial 1,1), although these are somewhat more slender than the Cnip example; nevertheless, a Yorkshire origin for the bead is likely. At the very least, that is where the jet originated.

Among the sand that became caked in the bead's perforation is a short length of thin organic material. Analysis has established that it is sinew, and this may well have been the thread on which the bead had been strung. (See 6.2.4, 'Note on the sinew', below.) Small fragments of similar material were also found in the fusiform bead's perforation. It is impossible to say whether the two beads had originally formed part of a single piece of jewellery, although this possibility should be borne in mind.

6.2.4 Note on the sinew

Susanna Kirk

A tiny fragment of thread from the drilled hole of the chunky jet bead (SF23) from Cnip Headland was analysed and imaged by optical microscope and scanning electron microscope (SEM) to characterise the type of thread used.

The optical and SEM images show a short length of fine, tightly packed fibres running parallel to one another (Illus 25). The fibres are not twisted, as would be expected for a textile-based thread. There are also no visible microstructures on the surface,



Illus 25 Photograph of the sinew in jet bead SF23 (© Susanna Kirk/NMS)

such as pores or scales, as would be expected for plant fibres or certain animal fibres such as wool. Therefore this thread fragment is most likely to be sinew, or animal tendon, which consists of tightly packed strands of collagen arranged parallel to one another. Sinew was used as thread in ancient societies and in geographical regions where other types of fibre were not available, such as the Arctic.

6.2.5 Discussion of the beads

Alison Sheridan

Regarding the fusiform bead, beads of this shape and size are well known from Early Bronze Age jet spacer plate necklaces in Britain and Ireland (Sheridan & Davis 2002), and the nature and degree of damage and wear on SF15 is characteristic of beads from old spacer plate necklaces. However, such necklaces are unknown in north-west Scotland; the nearest examples to Lewis are from Achcheargary Burn, Strathnaver, Highland (Stevenson 1939) and

Melfort, Argyll (*Proc Soc Antiq Scot* 19 (1884–5: 134–6)). Indeed, the Cnip Headland jet beads are the only examples of prehistoric jet from Lewis, with the exception of an unusual pendant from Reef Sands, Uig, discussed below. It seems likely that the fusiform bead was obtained from an old spacer plate necklace, through contacts to the east or south.

Spacer plate necklaces of jet and jet-like materials are known to have been made during the last two centuries of the 3rd millennium BC (with a few in East Anglia probably made around the 20th century BC), and to have continued in use – as fragments or individual beads – for up to several centuries in some cases. Radiocarbon dates recently obtained for NMS relating to this type of jewellery in Scotland include those for associated unburnt bone from Inchmarnock, off Bute (3635 ± 35 BP, GrA-34345, 2130–1900 cal BC at 95.4% probability using OxCal 4.1; date funded by Lord Smith of

Kelvin: Sheridan & Bradley 2007: 220) and for associated cremated bone from Easter Essendy, Angus (3710 ± 35 BP, GrA-32131, 2210–1970 cal BC at 95.4% probability using OxCal 4.1; Sheridan et al 2006: 205).

The radiocarbon dates obtained from the context in which the Cnip fusiform (and the other) bead were found – which, according to Hamilton's Bayesian modelling, suggest a deposition date during or around the 18th century BC – are consistent with indications that the fusiform bead was old when it was buried. Indeed, it may have been up to 350 years old, to judge from the aforementioned necklace dates. The discovery of individual components, or groups of components, from jet spacer plate necklaces is paralleled in the west of Scotland at several sites. The nearest of these is Cladh Andreis chambered cairn, Ardnamurchan, Highland, where four fusiform jet beads and a copper alloy awl attest to secondary use of a Neolithic monument (Harris et al 2011; identification of the beads and awl by the current author and by Dr Susanna Kirk). Other findspots include a cist at Scalpsie on Bute, where a single worn fusiform bead was found with a Yorkshire Vase Food Vessel, a copper alloy bead and cremated bones of an adult of indeterminate sex, the latter radiocarbon-dated to 3730 ± 30 BP (SUERC-37704 (GU23930), 2270–2030 BC; Sheridan 2013). The female sex of the adult whose remains lay with one of the Cnip beads is consistent with the pattern of associations for spacer plate necklaces and their components: spacer plate necklaces seem almost invariably to be associated with women (Sheridan & Davis 2002).

As for the chunky jet bead, as noted above it is likely that this, too, had been made in Yorkshire. Clearly it was deposited at broadly the same time as the fusiform bead and it could conceivably originally have been worn alongside it in a single piece of jewellery.

As mentioned above, the Cnip finds are not the only prehistoric jet artefacts to have been found on Lewis. In 1924, a Mr Malcolm Buchanan found an unusual jet pendant among human remains (of more than one individual) and what may have been grave or cist slabs that had been temporarily exposed on Reef Sands in the parish of Uig (Gibson 1934: 428–30 and fig 1.3). It was rumoured that a pot had previously been found nearby. Clearly of

jet, the object resembles an unusual spacer plate, but with only one longitudinal perforation close to one edge; thus it cannot have been used as a spacer plate, but rather as a pendant. It was clearly old when deposited, since one corner had broken off and two small transverse perforations had been drilled just below the fracture surface, to allow it to continue to be used as a pendant. The fracture surface had been worn smooth. Unfortunately, the associated bones were reburied in sand and will probably have been washed away; it is therefore impossible to obtain a radiocarbon date to check whether this, like the Cnip beads, was of Early Bronze Age date, but it is plausible given the description of the find context. It is interesting that two jet ornaments that are unusual within the overall canon of Whitby jet Early Bronze Age jewellery should have been found on Lewis.

The fact that jet jewellery made in the Whitby area ended up in Lewis (along with the bronze awl; 6.2.1 'The awl (SF14)' above) is testament to the extensive interactions that took place in Early Bronze Age northern Britain. The nature of, and reasons for, these connections have been discussed elsewhere (Sheridan 2008a: 251, 258; 2012b; 2013); in short, jet jewellery will have constituted a highly desirable, prestigious and quite possibly amuletic possession of the elite. Its enduring significance and value are attested in the length of time over which individual pieces were curated, passing down the generations as in the case of the fusiform bead.

7. MACROPLANT REMAINS

Susan Ramsay

All of the 15 bulk soil samples taken from burial matrices and from the body of the kerbed mound in Area C were processed by flotation for the recovery of carbonised remains, using standard methods, with sieves of mesh diameter 1mm and 500µm for flots and 4mm and 2mm for retents. The botanical remains were then examined using a binocular microscope at variable magnifications of $\times 4$ – $\times 45$.

The samples examined were generally devoid of carbonised remains. Only Sample 2 from Context 8 (windblown sand covering Sk 1 in Area A) contained any carbonised material, consisting of

a single indeterminate cereal grain and a fragment of carbonised grass stem. These are small enough to have been transported some distance by wind. None of the carbonised remains were suitable for radiocarbon dating.

8. ANALYSIS OF SOIL ORGANIC MATTER

BJ Keely

Thirteen soil samples from Cnip Headland were analysed to characterise the proportion and variability of organic matter present within the soils (Table 10). Elemental analysis was conducted to assess the abundances of the elements carbon (C), hydrogen (H), nitrogen (N), oxygen (O) and sulphur (S). Solvent extracts of the soils were analysed to determine the distributions of organic markers within the soils and pyrolysis was used to examine the non-extractable portion of the organic matter. The methods followed Einarsson et al (1983), Haynes et al (1991), Evershed & Tuross (1996) and Hasan (2010); full details of the methods used are given in the archive report. Illus 26–30 detail the results in graphic form.

Table 11 presents the nitrogen and hydrogen measurements, taken from the untreated soil, and the carbon and oxygen values from the acid digested

soil. The total organic carbon (TOC) contents of the Cnip Headland samples mostly indicate a soil with moderate organic content (Illus 26). One of the samples (S08, from under the skull of Sk 1) has low TOC and one (S12, from beside the skull and neck of Sk 1) has appreciably higher TOC. Percentage abundances were converted to atomic abundances for the computation of key element ratios (Table 12).

The values are consistent with the organic matter being dominated by terrestrial plant material, values in the range 0.4 to 1.4 being consistent with the values for humic and fulvic acids and for lignin/cellulose and wood. The difference in the O/C ratio between the most extreme samples (S07 and S10) would be consistent with a higher cellulose content in the latter, a sample of the matrix to the north-west of the Sk 1 skull.

The N/C ratios are mostly within the range for a nitrogen-poor system, indicating an environment in which the flora and fauna were limited. The values suggest that some nitrogen may remain in the form of protein/peptide or amino acid. Thus, organic matter preservation is moderate. Sulphur contents were below the limit of detection of the analyser.

Gas chromatography analysis of the total solvent extracts revealed them to contain relatively low

Table 10 Samples analysed and discussed in the organic soils report

Sample ID	Area	Context	Original sample no.	Description and location
01	C	18	17	Dark brown matrix of Cluster 2
02	A	12	11	Dark brown sand around isolated left fibula, Sk 1
03	A	27	5	Reddish firm sand on frontal bone and E of skull, Sk 1
04	A	11	10	Black-flecked sand across abdomen and to S, Sk 1
05	A	5	14	Matrix under thorax, Sk 1
06	A	5	12	Matrix around right leg, Sk 1
07	D	103	108	Matrix in pelvic area, Sk 2
08	A	5	15	Matrix under skull, Sk 1
09	D	116	11	Dark matrix NE of infant cranium, Sk 3
10	A	5	9	Matrix NW of skull, Sk 1
11	D	108	114	Lower burial matrix, Sk 3
12	A	5	7	Left lateral position of skull and neck region, Sk 1
13	D	103	104	Skull area, Sk 2

Table 11 Elemental abundances in <200µm soil fraction from Cnip Headland

Sample ID	% N	% Corg	% H	% S	% O
01	0.06	0.32	0.23	0.00	0.41
02	0.05	0.31	0.19	0.00	0.40
03	0.10	0.44	0.28	0.00	0.57
04	0.07	0.52	0.22	0.00	0.49
05	0.05	0.29	0.18	0.00	0.28
06	0.06	0.33	0.19	0.00	0.37
07	0.10	0.54	0.24	0.00	0.31
08	0.02	0.10	0.14	0.00	0.18
09	0.05	0.37	0.17	0.00	0.51
10	0.10	0.44	0.28	0.00	0.70
11	0.06	0.42	0.17	0.00	0.58
12	0.19	1.29	0.46	0.00	1.06
13	0.05	0.29	0.17	0.00	0.34

Table 12 Atomic elemental abundances and elemental ratios in <200µm soil fraction from Cnip Headland

Sample ID	Atomic N	Atomic C	Atomic H	Atomic O	H/C	O/C	H/N	N/C
01	0.41	2.70	22.99	2.55	8.53	0.95	55.98	0.152
02	0.33	2.58	18.38	2.47	7.11	0.96	55.98	0.127
03	0.70	3.69	27.43	3.55	7.44	0.96	39.12	0.190
04	0.51	4.34	21.52	3.08	4.96	0.71	42.26	0.117
05	0.35	2.42	18.25	1.74	7.53	0.72	51.47	0.146
06	0.39	2.71	18.59	2.32	6.86	0.86	47.24	0.145
07	0.69	4.50	24.02	1.91	5.34	0.42	34.99	0.153
08	0.14	0.84	13.49	1.11	16.02	1.31	94.88	0.169
09	0.38	3.05	16.87	3.16	5.53	1.04	44.13	0.125
10	0.73	3.66	27.68	4.38	7.57	1.20	37.79	0.200
11	0.40	3.47	17.22	3.61	4.97	1.04	42.92	0.116
12	1.32	10.77	45.25	6.61	4.20	0.61	34.17	0.123
13	0.36	2.39	16.80	2.15	7.03	0.90	47.01	0.149

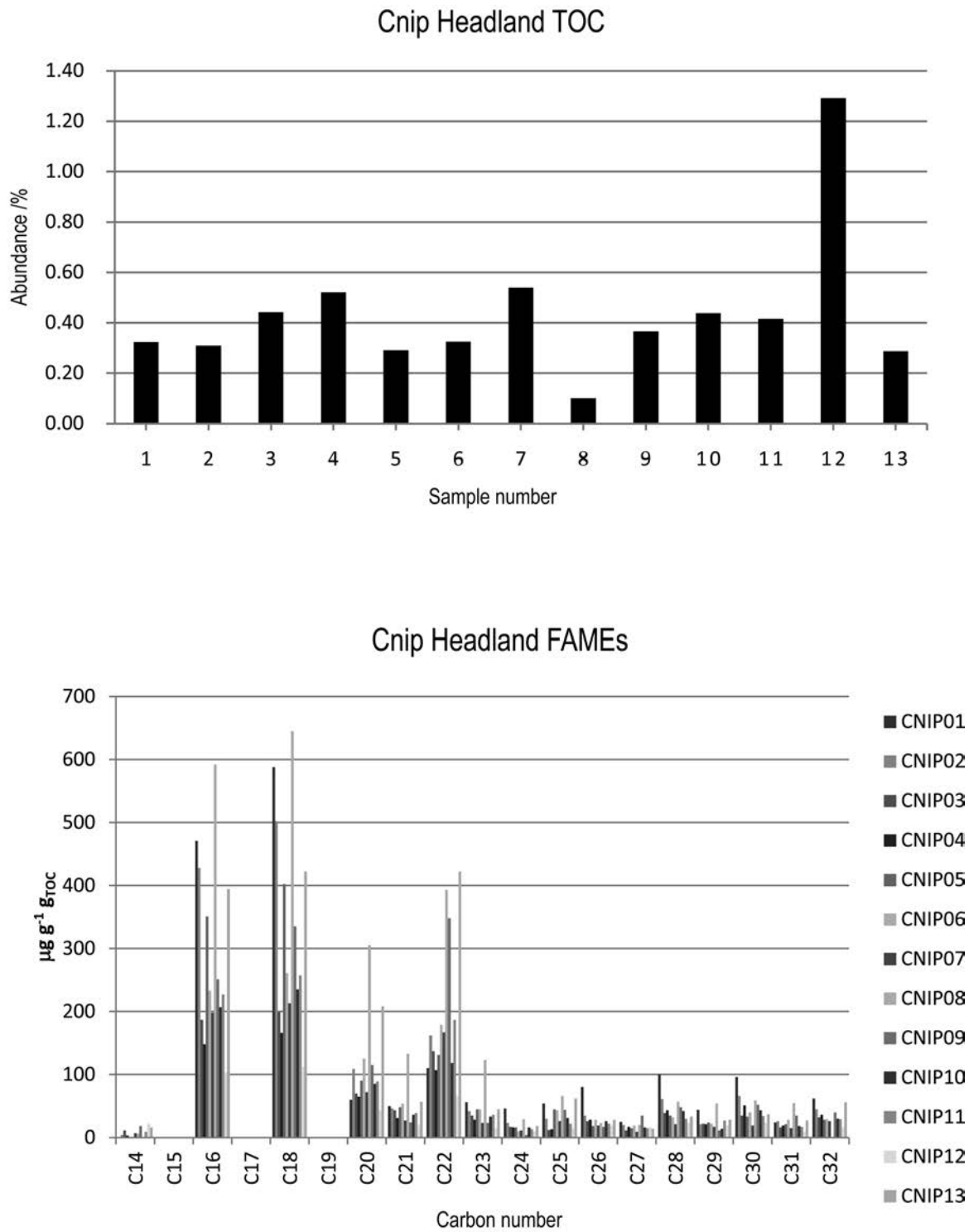

Illus 26 (a) Total organic carbon contents of <200µm soil fraction, with (b) fatty acid methyl ester (FAME) abundances in Cnip Headland samples plotted by carbon number of the fatty acid

levels of organic compounds, consistent with the low TOC values obtained, and to exhibit broadly similar distributions of components. The extremes are evident for Sample 04 (from the Sk 1 abdominal area), where the high molecular weight (HMW) components dominate, indicating a greater relative contribution from plant-derived organic matter, and Sample 08 (the matrix under the Sk 1 skull), where the low molecular weight (LMW) components dominate, possibly indicating a greater proportion of organic matter derived from the body.

Only one cyclic alcohol was observed: a C27 sterol, identified as cholesterol, detected in varying amounts in all of the extracts. This is likely to be derived from an animal source. Cholesterol occurs as a major sterol in animals, including in bone, and to a lesser extent in plants. It has been used as an indicator of animal inputs to soils (Puglisi et al 2003; Hjulstrom & Isaksson 2009). Whether it relates to the interred remains or to soil fauna such as earthworms is unclear. In the mammalian gut, cholesterol is microbially reduced to coprostanol, which has been shown to be a persistent marker for human faecal material (Bethell et al 1994). The GC-MS chromatograms were examined for ions pertaining to coprostanol. No evidence of coprostanol could be detected for the four samples examined by MS (S01, S04, S09 and S13).

Triacylglycerols (TAGs) are major components of plant oils and animal fats. Samples 08 and 11 did not contain detectable levels of TAGs, but TAGs were detected in the mass chromatograms of Samples 07 (from the pelvic area of Sk 2) and 09 (the darker matrix north-east of the Sk 3 cranium), with the latter containing a greater overall amount (Tables 13, 14 and 15; Illus 29). Although a plant origin cannot be ruled out, the TAG distributions in Samples 07 and 09 share more similarities with animal fats than with plant oils. However, an origin from a less well-known source should also be considered. It is notable, in this regard, that molluscs and crustaceans have been reported to contain quite different TAG distributions to plants and mammals, with high levels of palmitic and unsaturated C16 fatty acids being present (together with fatty acids having 18, 20 and 22 carbons). Notably, however, those distributions also contained substantial abundances of TAGs with fatty acids having lower numbers of carbon atoms.

Table 13 Percentage TAG composition and total response for Samples 07 and 09 (^asummed peak area of all TAGs, normalised to g_{TOC} ; * more than one regioisomer possible)

Sample ID	PPP	PMaP	C ₅₂ TAG	POP	PPO*	PPS*	SMaP*	OPS*	OPS*	SPS	SSP*	Total response ($\times 10^6$) ^a
07	62.2	3.4	2.0	3.3	6.0	14.1	0.6	2.2	1.2	6.3	5.0	28.86
09	48.0	1.4	3.0	2.7	6.2	25.9	1.2	1.7	3.6	6.3	5.0	552.13

Table 14 Bulk percentage fatty acid composition of the TAGs

Sample ID	P	Ma	S	O	L	P/S ratio
07	84.4	2.0	9.4	4.2	0.0	9.0
09	78.4	1.8	15.0	4.7	0.0	5.2

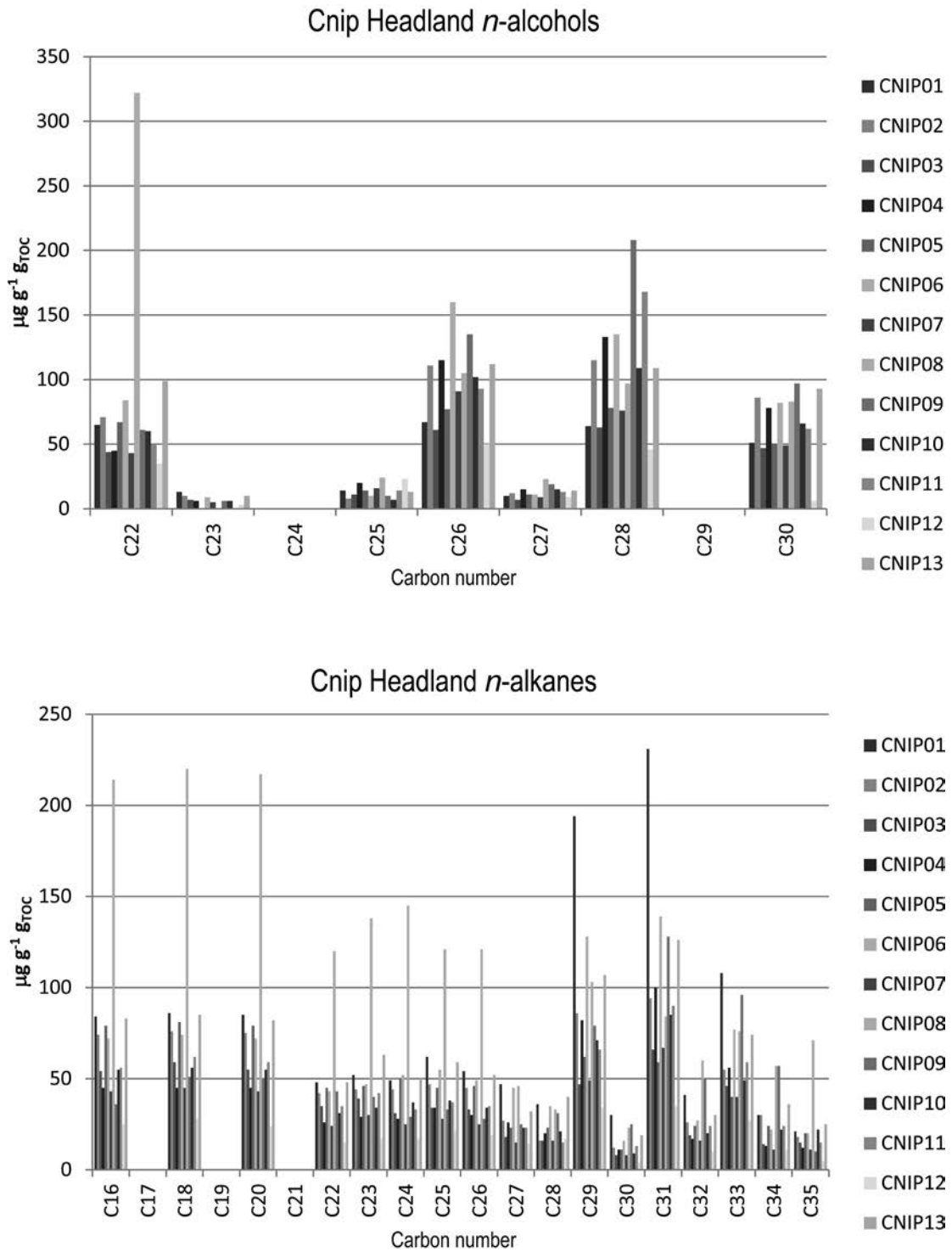

Illus 27 Alkanol abundances (a) and alkane abundances (b) in Cnip Headland samples plotted by carbon chain length

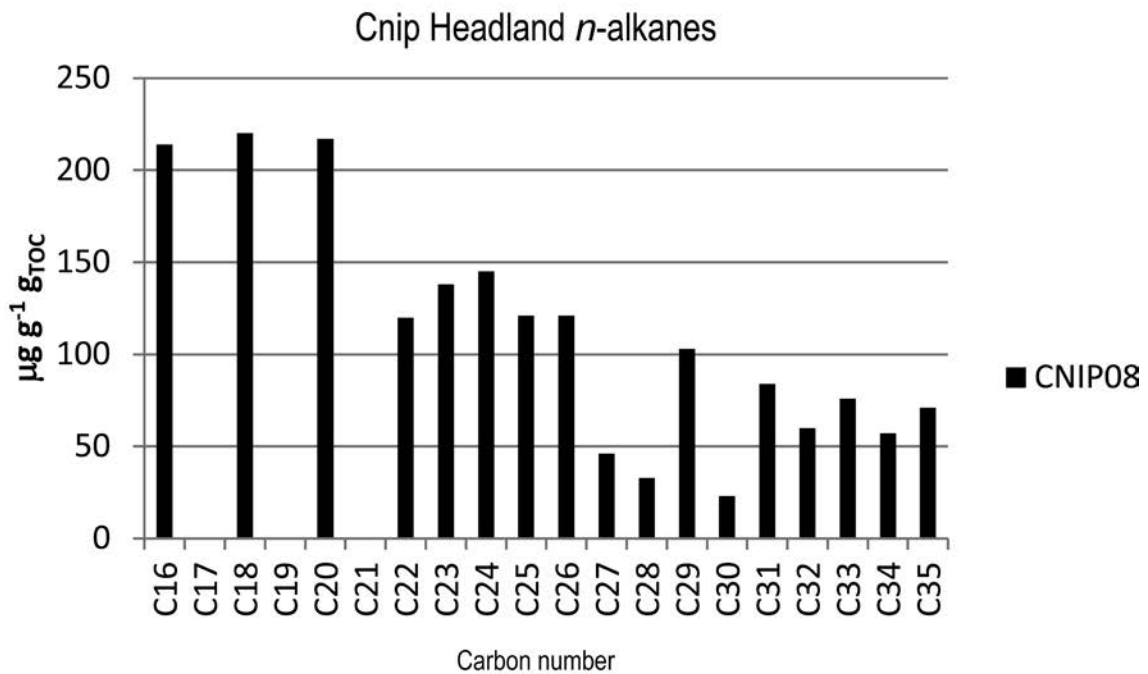
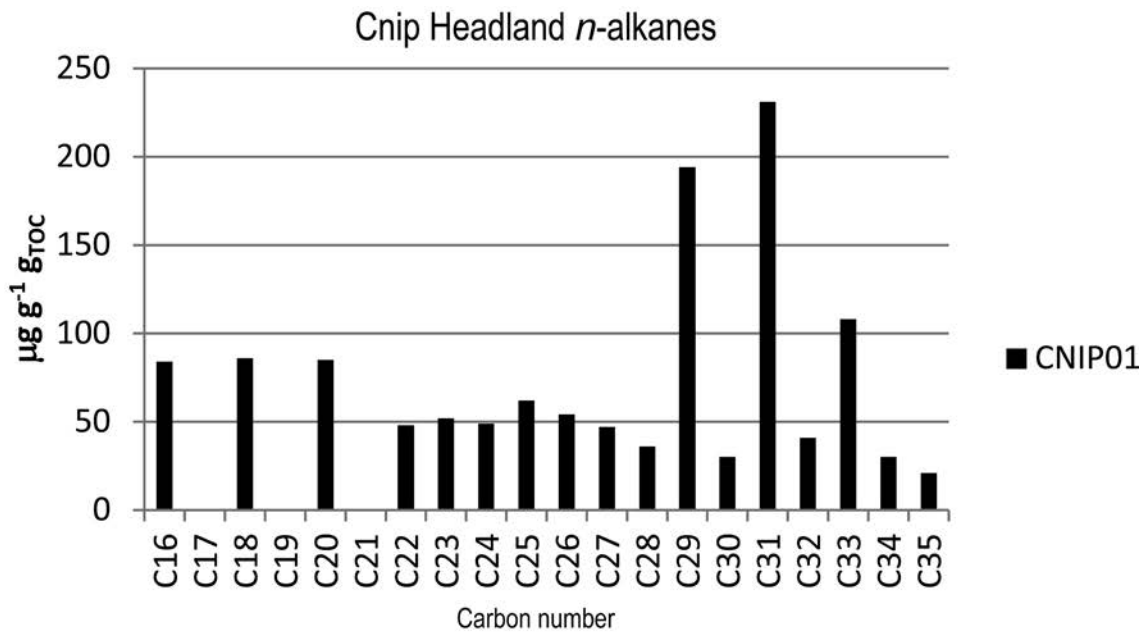

Illus 28 Alkane abundances in Cnip Headland Samples 01 and 08 plotted by carbon chain length

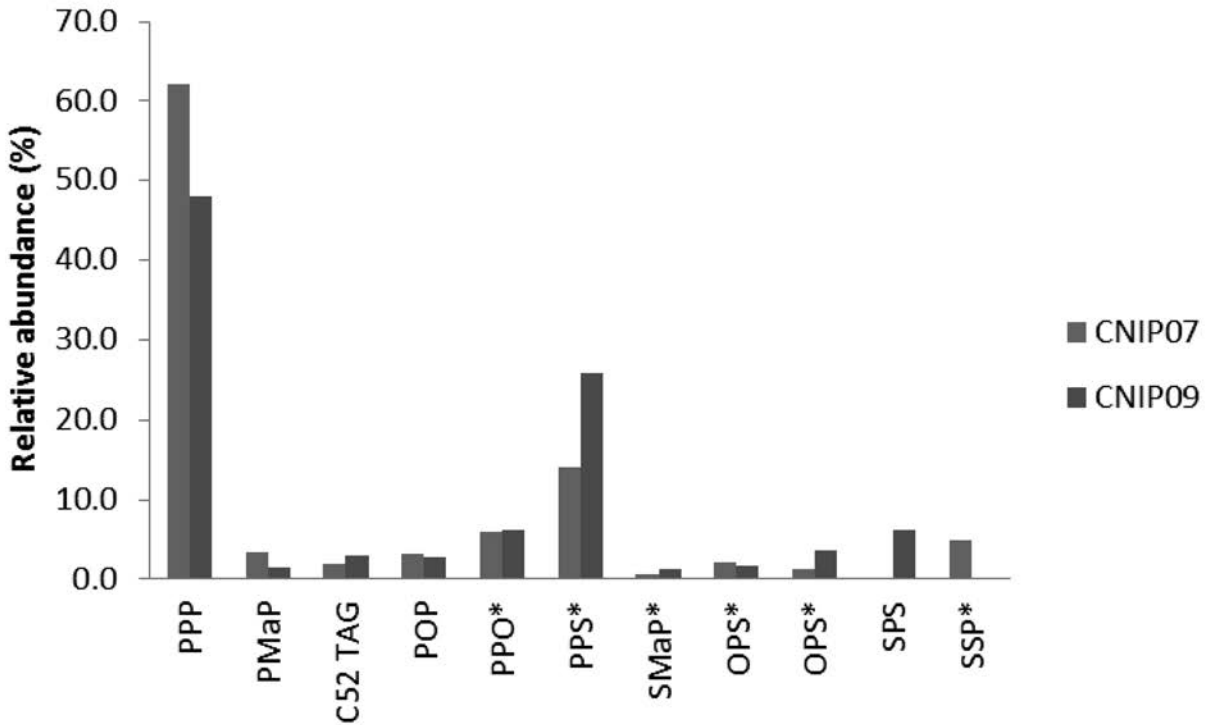

Illus 29 Distribution of TAGs in Samples 07 and 09. * indicates that more than one regioisomer is possible

Table 15 Potential precursor TAGs for the TAGs in Samples 07 and 09 (underlined TAGs are prominent components of animal fats (Hasan 2010); TAGs in italics are prominent components of plant oils (Mottram et al 1997); * indicates that more than one regioisomer is possible)

TAG in sample	Potential precursor TAG
PPP	PPPo*, PPOoPo*, PoPoPo
PPO*/POP	PPL*, PPOo*, PPOl*, PoPoO*, PoPoL*
PPS*	<u>PPO*</u> , <i>PPL*</i> , PoPO*, PoPL*, PoPoO*, PoPoL*
<u>OPS*</u>	<u>OPO</u> , <u>OPL*</u> , OPoO, OPoL*, LPL, LPOl
SSP*/SPS	OSP*, <u>OOPL*</u> , LSP*, <u>LOPL*</u> , LLP*, OSPo*, OOPo*, LSPo*, LOPo*, LLPo*

Amino acids, representing both free and protein amino acids, were detected in the hydrolysates of the majority of the soils, with the exceptions of Samples 02, 04, 05 and 06, all from Area A (see Table 16). Three samples exhibit particularly high amino acid abundances: S01 (Context 18 in Area C) and S07 and S11 (Contexts 103 and 108 in Area D). Resolution of the amino acids in these samples was extremely poor, precluding the identification of individual components. Instead, the amino

acids eluted as a broad unresolved complex mixture (UCM). Distinct groupings are evident between samples and, given the occurrence of amino acids in most of the samples and the variations in their distributions, it is likely that they relate to specific and varied sources. The hydrophobic amino acids, of which leucine is the most frequent and abundant in these soils, may reflect the most recalcitrant residues, remaining in the soil by virtue of their low solubility in aqueous media. The presence of

Table 16 Abundances of amino acids released upon hydrolysis of soil samples from Cnip Headland, normalised to grams of total organic carbon (TOC). (Asp = aspartic acid, Glu = glutamic acid, Hpro = hydroxyproline, Ser = serine, His = histidine, Gly = glycine, Thr = threonine, Arg = arginine, Ala = alanine, Pro = proline, Tyr = tyrosine, Val = valine, Met = methionine, Ile = isoleucine, Leu = leucine, Phe = phenylalanine, Lys = lysine. UCM = an unresolved complex mixture encompassing the components shaded in grey. A sum was taken of the abundances of the coeluting species.)

Sample ID	Amino acid abundance (µg/g _{TOC})														Totals			
	Asp	Glu	Hpro	Ser	His	Gly	Thr	Arg	Ala	Pro	Tyr	Val	Met	Ile		Leu	Phe	Lys
01	-	-	-	-	973.7 (UCM)	-	-	-	-	-	-	-	45.1	508.5	14.2	-	1541.5	-
02	-	-	-	-	-	-	-	-	-	-	-	-	-	-	-	-	-	-
03	8.7	21.2	16.9	1.4	-	5.6	-	-	-	-	-	-	-	-	-	-	-	53.8
04	-	-	-	-	-	-	-	-	-	-	-	-	-	-	-	-	-	-
05	-	-	-	-	-	-	-	-	-	-	-	-	-	-	-	-	-	-
06	-	-	-	-	-	-	-	-	-	-	-	-	-	-	-	-	-	-
07	-	-	-	-	1234.5 (UCM)	-	-	-	-	-	-	-	24.1	60.8	-	-	-	1319.4
08	-	-	-	-	-	-	-	-	-	-	26.3	10.1	5.6	243.6	1.0	-	-	286.7
09	-	39.3	18.0	5.9	-	6.4	-	12.7	5.0	2.1	-	12.8	7.0	8.1	86.7	8.3	-	212.4
10	-	14.5	21.0	-	-	-	-	-	1.9	-	-	-	-	-	-	-	-	37.5
11	-	163.5	22.1	-	-	754.7 (UCM)	-	-	-	-	26.4	249.3	20.0	-	-	-	-	1236.1
12	-	-	1.7	-	-	-	-	-	-	-	-	-	-	0.4	2.1	-	-	4.2
13	-	-	7.9	-	-	-	-	-	-	-	-	-	-	1.6	9.7	-	-	19.2

hydroxyproline is suggestive of collagen, in which it occurs in high frequency. Of particular note is the distinctive distribution of amino acids in Sample 11, where methionine is present in significant abundance. Although a probable source for such a high level of this amino acid has not been identified, its co-occurrence with glutamic acid is suggestive of a quite specific source. Similarly, the complexity of the distribution in Sample 09 points either to a quite distinctive source or to a higher degree of preservation (most likely as peptide/protein) in this sample.

In conclusion, the soils from Cnip Headland contain appreciable levels of organic matter, comprising a range of natural, product-derived organic residues that include complex structures. The distributions provide evidence of background signatures from vegetation, together with material that is likely to originate from the bodies. The more complex components, including TAGs and most likely peptides, indicate the preservation of signatures that relate to the bodies and/or to organic matter placed in the soil at the time of burial. The variations in the distributions indicate that these signatures, though challenging to interpret at this stage, may provide clues as to the nature of the remains when placed in the burial environment and may also provide information on features such as the dark matter adjacent to Sk 3 (Sample 09).

9. DISCUSSION

Olivia Lelong

9.1 Interpreting the sequence of events

The evidence excavated over four phases of work on Cnip Headland illuminates what took place there over more than a thousand years – from the agricultural activity that preceded the construction of the cairn, through its two phases of remodelling and the creation of burials around it (Illus 31). This section draws together all of the evidence available to date into an understanding of the sequence of events on the headland during the 3rd and 2nd millennia BC.

Excavation of the cairn established that, over several phases during the 3rd millennium BC, the ground on the headland was cultivated, building up a thick layer of dark brown humic soil (Close-Brooks

1995: 266). The excavator of the cairn thought it likely that this had taken place around the middle of the millennium: the construction of a Bronze Age funerary monument on Beaker-period cultivation soil finds parallels elsewhere in the Western Isles – for example, at Rosinish, Benbecula (Crawford 1977) and Cladh Hallan, South Uist (Parker Pearson et al 2004). After cultivation ceased, people constructed a D-shaped, kerbed cairn containing a rectangular cist on the ard-marked surface. They placed the remains of an adult aged 35–45 in the cist and covered it with a low cairn of local stones (Close-Brooks 1995: 259).

At some later point, people cleared the centre of the cairn down to ground level. They tossed the stones over the kerb and built a circular corbelled cist in the hole they had made, pulling out most of the bones from the earlier burial and dismantling one end of the first cist in the process. In the new cist, upside down, they set an urn that held cremated bone and a black deposit that clung to the pot's interior. It had originally been viscous or liquid; analysis could not establish whether it was animal or vegetable in origin, but it was thought to resemble burnt food residues like those found in later prehistoric pots (Close-Brooks 1995: 263). This took place at some point between 1883 and 1537 BC (95% probability; GU-1174), as indicated by a Bayesian-refined radiocarbon date from the black substance (5.3 'Radiocarbon dates and Bayesian analysis' above). The hole in the cairn was filled up with sand as well as burnt material, cattle bones and teeth, the remains of edible shellfish and human bones (perhaps from the earlier burial), all sealing the corbelled cist. The excavator suggested that these could have been the remains of a funeral feast, or midden generated in a nearby settlement (Close-Brooks 1995: 264).

Human remains were also placed in the ground around the cairn on at least five occasions. Bayesian analysis of the radiocarbon dates indicates that this phase of activity, which coincided with the remodelling of the cairn described above, lasted for up to 150 years. It began at some point between 1770 and 1690 BC and ended between 1735 and 1620 BC (both 95% probability), with a 68% probability that it spanned only 100 years (5.3 'Radiocarbon dates and Bayesian analysis' above).

On one of these occasions, people heaped up

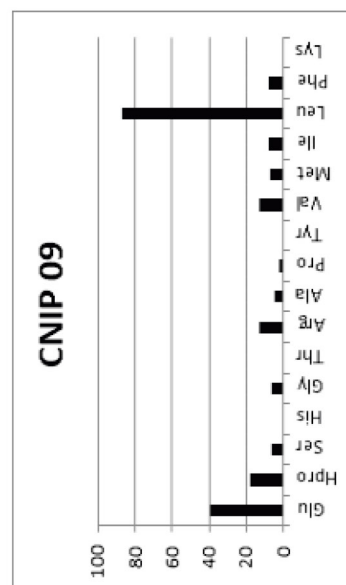
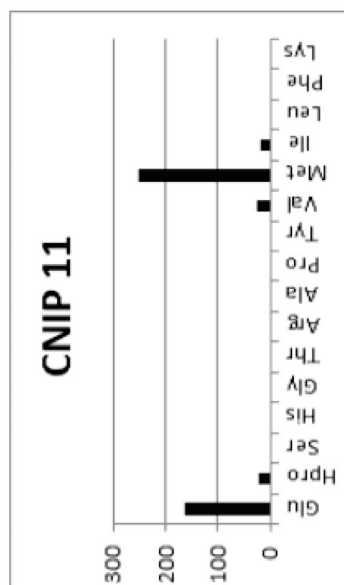
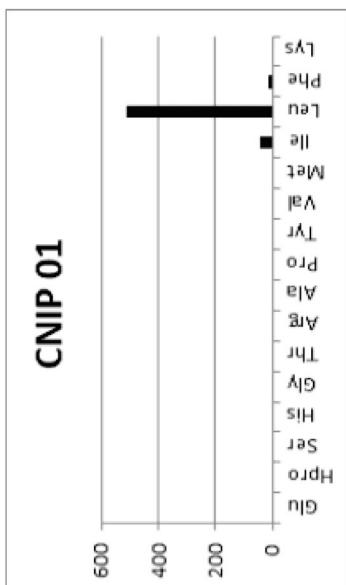
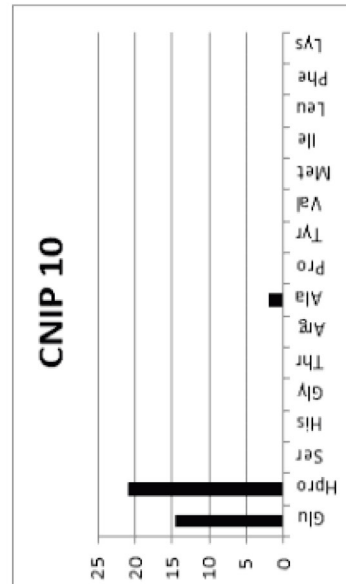
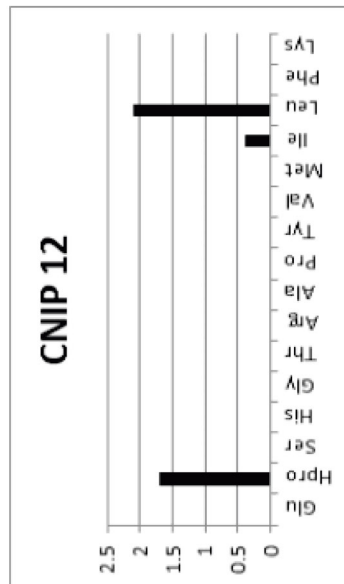
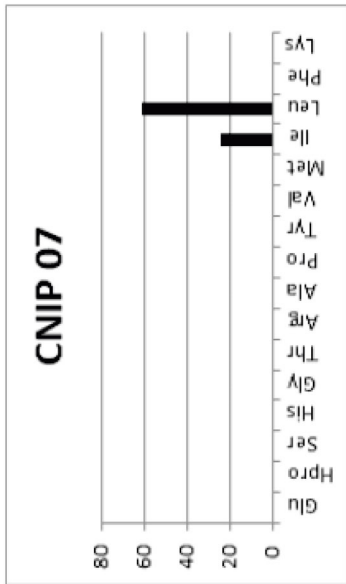
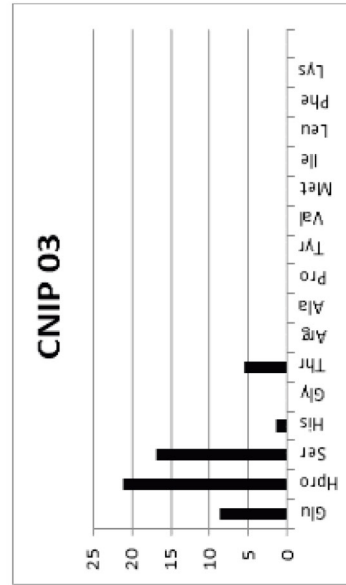
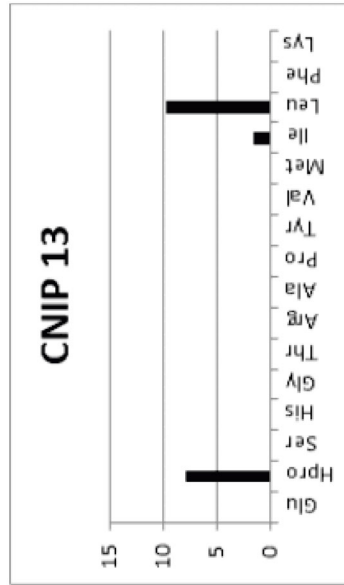
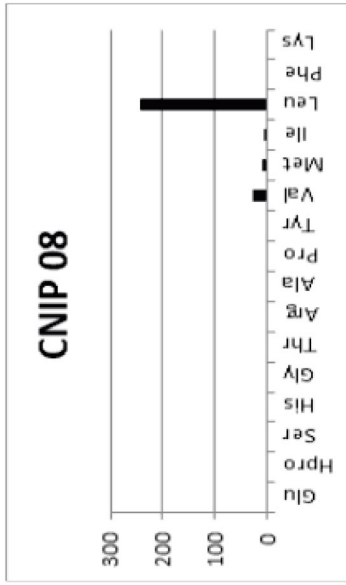

Illus 30 Abundance profiles of amino acids isolated from Cnip Headland soils



Illus 31 The excavated cairn from the south (© Simon Rivett)

layers of sand to form a mound to the east of the cairn and built a partial kerb around it, two to three courses high (Area C). As they were building the mound, they put a cluster of disarticulated bones from two probable adults, an infant and a sub-adult at its northern edge (Cluster 1), along with a bronze awl. After spreading more sand across the mound, they set more bones in two roughly parallel clusters (2 and 3) – again from two adults (both women aged 40–44), an infant and a child of 6–7 – placing a worn jet bead next to large bones from the lower body in each cluster (Illus 32) (see above, 5.1 ‘Skeletal analysis’; 6.2 ‘Artefacts with the human remains in Area C’).

Analysis of bone histology has established that after death, the bodies of the adults and children had been treated in a way that kept intestinal bacteria from attacking the bone. Most of the soft tissue had decayed by the time of burial, but the bone was well preserved (5.2.4 ‘Bone histology analysis’ above). The bodies may have been left exposed on the surface to decay, protected from carnivores; alternatively, they were dismembered, although no signs of butchery were found. Given the rarity of repeated elements across the contexts (C17 and

C25) and the similarity in age ranges represented in each, the bones may have come from just two adults, a child and an infant; however, they could just as probably represent more people from across those age groups. Whoever placed the bones made an effort to arrange them in ways that approximated human anatomy, although bones from individuals of different ages were combined. At least one partial limb, an adult’s lower arm (SF19), was still held together with soft tissue when it was placed on the mound.

On another occasion, someone dug a shallow pit to the north, lined it partly with upright slabs and packed them in place with sand. In it they placed the body of an adolescent (Sk 1), possibly male (assuming all parts came from the same person, for which there is no compelling evidence either way). Bone histology analysis has found that, as with the remains in Area C, post-mortem treatment had prevented bacteria from attacking the bone (5.2.4 ‘Bone histology analysis’ above). Assuming the different parts of Sk 1 all came from the same adolescent, the partial articulation and good preservation suggest that his body was left exposed for a while and then retrieved and buried



Illus 32 Clusters 2 and 3 in Area C from the south, with the stone-lined grave in Area A in the background

after most of the soft tissue had decayed but while some parts were still held together. However, parts of both arms and legs were left behind or put to use in another context. The body seems to have been in several parts – head, torso and legs – with some limbs missing or in anomalous positions (Illus 33). The body was placed on the right side with the head to the west, facing south; some substance on or beside the head left a distinctive red stain, and pieces of boar's tusk and a seal's tooth may have hung around the neck in a small bag. The upper and lower body were partly decayed: several vertebrae slipped out of alignment with the rest of the spine, perhaps as the remains were wrapped and carried to the pit, and a lower leg bone (fibula) and upper arm bone (humerus) placed with the body were already skeletonised and disarticulated from the rest.

The pit also contained other bones, from the hands and feet of at least one adult. The small size of the bones and their associations with the main

burial – particularly the ankle bone (talus) found adhering to the thoracic vertebrae – could mean they are the remains of another person (or people) whose body was curated after death in the same spot as the adolescent's, either simultaneously or previously, and whose bones became mingled with his and were also gathered up for burial in the pit. Finally, slabs were set above the stone lining, possibly forming a corbelled capping (Illus 34).

On another occasion, someone scooped a small pit into the sand (Area D) about 4m to the east of the cairn to hold the body of a stillborn baby (Sk 3). The body lay with the head to the south-east, facing north. Clean sand was spread over it. Later, another shallow pit was scraped out directly above to receive the body of a woman aged 40–44 (Sk 2) (Illus 35). She was placed on her left side with her head to the south-west, facing north or north-west. She had suffered severe dental problems in life and lost several teeth as a result, and there was evidence



Illus 33 The burial in Area A, from the east

of physiological stress during her childhood (5.1 ‘Skeletal analysis’ above). Like the adolescent in Area A, her body seems to have been in several parts. However, bone histology analysis showed that her bones had been subjected to a greater degree of microbial attack than those in Areas A and C. The most viable interpretation is that her body was buried somewhere else for a time, so the putrefaction process was more advanced than if it had been left above ground to decay, and was then exhumed and reburied above the infant burial (5.2.4 ‘Bone histology analysis’ above). As with Sk 1, only parts of her body (excluding, for example, the right leg and left innominate) were retrieved and reburied here.

On yet another occasion, people dug another shallow pit a few metres to the west of the cairn,

clipping the earlier cultivation soil, and lined it partly with upright slabs. In it they placed the body of a man aged 35–40, lying on his right side with his head to the east and facing north (Dunwell et al 1995a). Beside his head they put a coarse, plain pottery vessel, of simple bipartite form and poorly made (Cowie 1995), which was probably a late Food Vessel (N Wilkin, pers comm). During life the man had engaged in strenuous physical activity that affected the bones of his lower back and left shoulder. He had also suffered a severe blow to his face from a blunt object, which had led to infection of the mandible, and this damaged side of his face lay downwards in the grave. The wound and infection had left him with limited jaw movement and as a result he probably favoured soft foods that were easier to eat; this had in turn led to increased



Illus 34 The stone-lined grave in Area A, with collapsed capping, from the south

dental caries and abscesses (Bruce & Kerr 1995).

Similarities in the burial matrices between the three grave pits suggest similar formation processes and hint at common burial rites. Reddish-brown fine sand lay around the bodies in Areas A and D, and reddish streaks and patches were noted around the bones of the adolescent (Sk 1) and the man (Dunwell et al 1995a: 283). Fine black sand also lay by the arm of the adolescent and under the man's pelvis (ibid). Analysis of soil organic matter found distinct differences between different deposits from Areas A, C and D, although the results are difficult to interpret (8 'Analysis of soil organic matter' above). The higher cellulose content in the burial matrix just north-west of the adolescent's skull could derive from the putative bag that held the pieces of ivory, while a similar signature in the black-flecked matrix in the abdominal area could derive from wrapping material. Traces of triacylglycerols around the pelvis of the woman in Area D (Sk 2)

and by the head of Sk 3 derive probably not from decay of the bodies but from another source such as molluscs or crustaceans (8 'Analysis of soil organic matter' above), an interpretation that accords with the limpet and oyster shells placed with the stillborn infant.

The excavators of the man's grave considered it likely that it had been covered with a mound of sand that was retained by a stone kerb, traces of which remained (Dunwell et al 1995a: 283). A similar arrangement of stones extending from the Area A stone setting may have likewise been a kerb remnant (Illus 34). Dunwell et al (ibid: 286) note the occurrence of sand mounds with stone kerbs elsewhere in the Western Isles, for example covering the corbelled cist containing a multiple inhumation at Rosinish, Benbecula (Crawford 1977). Any mounds of sand that covered the burials, including the Area C mound, must have been finally covered with a layer of turf or stones that would have



Illus 35 The Area D burial before excavation (© Carol Knott)

prevented the rapid erosion of the sand.

At least 200 hundred years later another, smaller cairn was built over the first one, which by then would have appeared as a sandy or grassy mound (Close-Brooks 1995: 270). This new cairn had an inner and an outer kerb, and the inner one held the cremated bones of a young, possibly male adult along with pyre material, sealed with tightly packed stones. The builders may have also packed sand or sandy turves between the kerbs, although no traces of it remained on excavation (*ibid*). Although no radiocarbon dates were obtained for this last phase of cairn construction, other monuments of this kind on the mainland have been shown to date to *c* 1450–1200 BC (Sheridan 2012b: 180).

9.2 Burial practices on Cnip Headland

The evidence shows that over a handful of generations, people were carrying out a sequence

of rites on Cnip Headland that involved both the cremation and the full and partial exhumation of the dead and their final deposition in and around a monument that was reworked several times. Juxtapositions between the remains of different people may have been metaphors for the dead and their connections in life, illuminating their relationships and identities (Brück 2004a). The woman (Sk 2) in Area D may have been the mother of the stillborn buried previously beneath, some time before. The bodies of older people whose small bones were found with the adolescent (Sk 1) may have been left to exhumate in the same spot as his, one devoted to a particular family or community, and their bones were intentionally or accidentally placed with his. In Area C, the two adults, child and infant (and possibly others of the same ages) may have all belonged to one family, hence their burial together, but the selection of body parts and their combination on the mound may represent

something more complex. The more or less complete body represented by the bones could have signified a broader kin group to which the dead belonged, with the individual clusters standing for distinct lineages within it. The parallel Clusters 2 and 3 in Context 17 seem to evoke this especially – each with a pelvis and sacrum lying adjacent at its centre, those substantial bones from the reproductive cores of two women.

The artefacts all had life histories which led up to and gave meaning to their final deposition with the bodies. The jet beads placed with Clusters 1 and 2 in Area C once formed part of one (or two) complex, impressive piece(s) of jewellery, the wearing of which may have been a kind of ‘supernatural power dressing’ (Sheridan 2008b: 70). Jet spacer plate necklaces may have been thought to have amuletic properties, perhaps because of their electrostatic properties and the static charge that rubbing the beads produces (Sheridan 2003). These beads bore the polish and wear acquired from jostling against skin, clothing and other beads and even carried wisps of the sinew that had joined them (6.2.4 ‘Note on the sinew’ above). They may have been small, powerful charms, redolent of places, journeys, stories and personalities that fed into the social contexts and identities of the dead, and they certainly illustrate links between communities on Lewis and others on the mainland. Perhaps they came from jewellery long held by the family and they symbolised the lineage of the deceased, or they were already ancient heirlooms when they were strung with other beads to make a necklace (Woodward 2002). Dismantling the necklace(s) could have been a metaphorical act undertaken at the time of burial, echoing the physical decay of the bodies into separate bones and the fragmentation of a family through the deaths of multiple generations. The awl in Cluster 1 may have evoked what one of the dead had done and created, or it may have stood for things other people had made for her (Brück 2004b: 317).

The four pieces of ivory found by the head of the adolescent in Area A came from the mouths of boars and what was probably a young seal – physically powerful animals that use their tusks and teeth to forage and kill (6.1 ‘Worked bone in Area A’ above). Each piece would have held a place in a story, perhaps about the hunt and the hunters and

how it was won. He may have worn them close to his head and throat as a kind of protection or to harness the animals’ prowess and power, whether in life if they were his own prized possessions or in death if they were graveside gifts.

The burials around the cairn were all conducted with reference to it. The bodies of the adolescent, woman and man were laid with their heads towards it, as if those who buried them were standing at their feet and facing the cairn. They lined the upper sides of the pits for the adolescent and adult man with upright stones that curved around their heads and upper bodies, as if it was important to delineate them as distinct from the cairn, to protect the graves on that side or to create a screen against which to view the remains for the last time. The disarticulated bones in Area C were similarly arranged, with the paired pelvis and sacrum in Clusters 1 and 2 each placed as if the heads of the recomposed individuals lay towards the cairn. In composing these burials with reference to the ancient cairn, members of the community may have been highlighting connections between ancestors and the recently dead or their beliefs about the past and themselves (Brück 2004b: 310). The creation of a new receptacle in the cairn and then a new, doubly circled cairn on top of it, both to hold cremated bone, suggests that people continued to rework ideas about the importance of lineage into the late 2nd millennium BC.

9.3 Fluid identities

By the time these various remains were placed in the ground, having first been transformed in another context, they may have no longer stood simply for the individuals who had inhabited them in life. They had moved beyond the present to become part of the mythic past and now they signified other, more fluid social identities that were nevertheless vital to the living.

Although they were handled in varying ways after death, there are common threads in the post-mortem treatment of most of the human remains recovered, with the exception of the infant in Area D. (The bone histology of the previously excavated inhumed adult males (Close-Brooks 1995; Dunwell et al 1995a) was not examined as part of this study.) All the rest went through some process of transformation after death, one facilitated by the living and involving cremation

or excarnation followed by burial, and in one case primary burial, exhumation and secondary burial. All of these processes required the devotion of effort, time and planning by those still living, and all of them also *took* time – for bacteria or fire to consume soft tissue, expose bones and fragment bodies. They would have served social, spiritual and emotional purposes for the living as well, giving them time to make their own intellectual and emotional journeys and find a new order for the world that death had disrupted (cf van Gennep 1960; Brück 2004b: 326). The different treatment of the stillborn baby, whose body was simply buried, provides an illuminating contrast for interpreting contemporary ideas about identity, personality and experience. If a person who had died without ever living outside the womb or developing a character did not require or merit post-mortem alteration, were the processes to which the others' bodies were subjected perhaps intended to dissolve identities that had built up during life, to purify personalities, to transform individuals into metaphysical entities that were acceptable to an idealised ancestral community?

These burials, along with an increasing corpus of evidence for partial and multiple burials elsewhere in Britain and Ireland, challenge the notion of an emerging 'ideology of the individual' in the Early Bronze Age that was concerned with wealth, prestige and social status, expressed in the rite of individual burial (for example, Renfrew 1974; Shennan 1982). The concurrent practices of cremation, excarnation and the inhumation of whole and partial bodies hint at the different ideas that lay behind these varying approaches to the treatment of the dead. Far from expressing a concept of personhood as essential and ahistorical with firm boundaries – a model with its own historical origins in the Enlightenment – these many complex treatments of the dead suggest that the self was often perceived as a fluid, permeable entity that was constructed through a person's relationships to others (Brück 2004b: 311–12). The ways that bodies were treated and manipulated also show that at least certain members of society were very familiar with how a skeleton fitted together, knowledge that could only have arisen through their regular handling of defleshed remains. Other instances of human remains in various configurations and combinations from across Scotland may have been, like the burials at Cnip Headland, expressions

of complex perceived links between the deceased and their relationships to the living in the Early Bronze Age.

On the nearby island of Pabay Mor, for example, the jawbone of an infant was found along with other disarticulated bone overlying the crouched burial of a man who had died 1450–1290 BC (Barrowman & Innes 2009: 11). At Allasdale Dunes on the Hebridean island of Barra, five oval, stone-lined pits were dug into soil that had been cultivated during the 3rd millennium BC. They held flexed, whole inhumations, partial disarticulated remains and deposits of cremated bone, some apparently buried together at the same time (Wessex Archaeology 2008). In one grave (303), for example, a few cremated skull fragments from a young infant had been placed over the head and upper body of another infant who died 1730–1520 BC. On the northern mainland at Chealamy in Strathnaver, an oval cist dug into a hillock contained the partial skeleton of a man aged 25–30 years, accompanied by a Beaker (Gourlay 1984). The skeleton consisted only of the fifth lumbar vertebra, sacrum, pelvis and legs; the head, abdomen and feet were all missing. No cut marks were visible on the bones and their good condition precluded decay in the cist as a viable explanation for the absence of the other body parts (Harman 1984), so it must have been buried in a partial state.

Similar practices are evident farther south. At Mill Road Industrial Estate in West Lothian, for example, a cist held the skull and part of the femur of one or more adults, along with the partial, disarticulated remains of four children aged nine to ten and another aged four to six, along with some cremated bone and three children's teeth, and all the bodies were defleshed when they were buried in the cist (Cook 2000). The radiocarbon-dated individuals died between 2210 and 2030 BC. The excavator suggested that the cist was designed and built so that it could be re-opened and more human remains placed in it over time. At Barns Farm in Fife, several cists, large pits and graves were dug into a hillock and later covered with a barrow (Watkins 1982). Three of the pits held the remains of six heads from adolescents, children and an adult along with the cremated bone of another child (Pit 6). Cist 1 held the tightly flexed skeleton of a male in his early twenties, along with a handful of cremated bone

from a young adult female. Another cist (4) held the tightly flexed body of a woman in her early thirties, wearing a fine necklace of shale disc beads with a Beaker behind her lower legs; the upper, perforated halves of two broken jet pendants were also put in the cist and the unusable, unperforated portions were presumably kept by the mourners. The broken pendants evoke the single jet beads placed in Area C – symbols of personal and communal narratives or of the connections between people, places and events?

The evidence from Cnip Headland that bodies were curated for a time after death also prompts at least loose comparison with Cladh Hallan on the island of South Uist, about 125km to the south (Parker Pearson et al 2005; 2007). Here several bodies belonging to adults, two children, an infant and two dogs were buried in pits beneath the floors of three conjoined roundhouses before their initial floors were laid and also during a subsequent phase. The tightly flexed bodies of the adults had been re-arranged post mortem. A woman's teeth were removed and placed in her hands, and after her bones had lost most of their collagen the knee was broken off and put in a pit outside the house. What appeared to be the burial of an adult male proved in fact to be made up of three individuals, although the bones had been carefully arranged in anatomical position. Furthermore, there was evidence of arrested microbial attack and partial mineral alteration on the adult male bones, and the excavators propose brief immersion in a peat bog as the most likely mechanism, along with possible evisceration. The woman is likely to have been kept wrapped tightly above ground after death, preserving her bones' articulation and protecting her remains from scavengers.

The houses at Cladh Hallan were built over five deposits of cremated bone, two of which dated to 1750–1530 BC, which themselves overlay a cultivated soil of the mid to late 3rd millennium BC. Some of the people had been dead for several decades when they were buried in and under the houses between 1310 and 1150 BC (Parker Pearson et al 2007). Their presence has been interpreted as representing 'a fundamental religious transformation in island life when the old beliefs gave way to the new, not through their total rejection but by their incorporation into the very foundations of the new'

(Parker Pearson et al 2005: 543–4). Communities were referring back to their histories in the siting of these new, imposing houses above ancestral remains, even as they shifted their focus from the power of ancestors to express changing beliefs about the world through their domestic architecture.

Over a thousand years earlier on the island of Lewis, a community built a monument to its ancestors on soils they had ploughed, and successive generations elaborated and reworked the meaning of this hillock overlooking the sea. The rites they practised involved the physical transformation of bodies, but their real meaning may have involved metaphysical transformation.

People buried the remains of the dead in particular configurations that may have expressed relationships to long-dead ancestors as well as to those still living, accompanied by rites that may have finally separated the recently dead from the living and joined them to their lineages (Thomas 1999: 57). The worn jet beads, the awl, the pieces of ivory and the pot may have been heirlooms that signified adherence to ancient beliefs or long-held traditions. The placing of marine ivory and shellfish with the more usual accompaniments may represent a particular blend of practices that developed in the Western Isles.

Burial activity may have continued beyond the period 1770–1620 BC until the construction of the final kerbed cairn in 1450–1200 BC (Sheridan 2012b). Erosion may have exposed the skull of a man who died between 1600 and 1421 (SUERC-24965), which over a thousand years later came to be buried in Cnip wheelhouse, perhaps symbolising links with the mythic past (Armit 2012: 225). Winds will continue to breach the machair on Cnip Headland and human remains may continue to emerge from the sands, creating future opportunities to glimpse the dynamic nature of Bronze Age burial practice on Lewis.

10. ACKNOWLEDGEMENTS

The project was funded and monitored by Historic Environment Scotland and the excavation was carried out with the assistance and osteological expertise of Maureen Kilpatrick. Many thanks to Dave Roberts for assistance in the field; to Rachel and Chris Barrowman for their help and support;

to Keith and Susan Stringer for information on the discoveries; to the Valtos Trust for permitting access; to members of the Uig community for their interest; and to Dr Alan Leslie of Northlight Heritage and Roderick McCullagh of Historic Scotland for support and advice. Thanks also to Alan Leslie, Gavin MacGregor and Neil Wilkin, whose

comments on earlier drafts of this paper improved it considerably, and to Mary MacLeod Rivett and Simon Rivett, who went out of their way to provide photographs of the site. Ingrid Shearer prepared the site illustrations, Marion O'Neil did the artefact illustrations, Alison Sheridan photographed the beads and Susanna Kirk photographed the sinew.

11. REFERENCES

- Albert, M, Mulhern, D, Torpey, M A & Boone, E 2010 'Age estimation using thoracic and first two lumbar vertebral ring epiphyseal union', *Journal of Forensic Sciences* 55(2): 287–94.
- Annable, F K & Simpson, D D A 1964 *Guide Catalogue of the Neolithic and Bronze Age Collections in Devizes Museum*. Devizes.
- Armit, I 1994 'Archaeological field survey of the Bhalto (Valto) peninsula, Lewis', *Proc Soc Antiq Scot* 124: 67–93.
- Armit, I 2006 *Anatomy of an Iron Age Roundhouse: The Cnip Wheelhouse Excavations*, Lewis. Edinburgh: Society of Antiquaries of Scotland.
- Armit, I 2012 *Headhunting and the Body in Iron Age Europe*. Cambridge: Cambridge University Press.
- Armit, I & Shapland, F in press 'Death and display in the North Atlantic: the Bronze and Iron Age human remains from Cnip, Lewis, Outer Hebrides', in Mulville, J (ed.) *Proceedings from the 2010 Hebridean Archaeology Forum: Journal of the North Atlantic. Special Volume*. Steuben, ME: Eagle Hill Institute.
- Barrowman, R & Innes, L 2009 'A Bronze Age burial from Pabay Mor, Isle of Lewis, Western Isles', *Scottish Archaeological Internet Reports*, 29. <https://doi.org/10.5284/1017938>
- Bass, W M 1995 *Human Osteology: A Laboratory and Field Manual*. 4th edn. Columbia, MO: Missouri Archaeological Society.
- Bayliss, A, Shepherd Popescu, E, Beavan-Athfield, N, Bronk Ramsey, C, Cook, G T & Locker, A 2004 'The potential significance of dietary offsets for the interpretation of radiocarbon dates: an archaeologically significant example from medieval Norwich', *Journal of Archaeological Science* 31: 563–75.
- Bell, L S, Skinner, M F & Jones, S J 1996 'The speed of post mortem change to the human skeleton and its taphonomic significance', *Forensic Science International* 82: 129–40.
- Bethell, P H, Goad, L J, Evershed, R P & Ottaway, J 1994 'The study of molecular markers of human activity: the use of coprostanol in the soil as an indicator of human fecal material', *Journal of Archaeological Science* 21: 619–32.
- Birck, J L 1986 'Precision K-Rb-Sr isotopic analysis – application to Rb-Sr chronology', *Chemical Geology* 56(1–2): 73–83.
- Brickley, M & McKinley, J (eds) 2004 *Guidelines to the Standards for Recording Human Remains, IFA Paper No. 7*. Southampton: BABAO.
- Bronk Ramsey, C 1995 'Radiocarbon calibration and analysis of stratigraphy: the OxCal program', *Radiocarbon* 37: 425–30.
- Bronk Ramsey, C 1998 'Probability and dating', *Radiocarbon* 40(1): 461–74.
- Bronk Ramsey, C 2001 'Development of the radiocarbon calibration program', *Radiocarbon* 43: 355–63.
- Bronk Ramsey, C 2009 'Bayesian analysis of radiocarbon dates', *Radiocarbon* 51(1): 337–60.
- Bronk Ramsey, C 2010 OxCal v4.1.7 <https://c14.arch.ox.ac.uk/oxcal.html>
- Bruce, M & Kerr, N 1995 'Skeletal analysis', in Dunwell et al 1995a: 283.
- Brück, J 2004a 'Early Bronze Age burial practices in Scotland and beyond: differences and similarities', in Shepherd, I A G & Barclay, G (eds) *Scotland in Ancient Europe*, 179–88. Edinburgh: Society of Antiquaries of Scotland.
- Brück, J 2004b 'Material metaphors: The relational construction of identity in Early Bronze Age burials in Ireland and Britain', *Journal of Social Archaeology* 4(3): 307–33.
- Buck, C E, Cavanagh, W G & Litton, C D 1996 *Bayesian Approach to Interpreting Archaeological Data*. Chichester: John Wiley & Sons.
- Buikstra, J E & Ubelaker, D H (eds) 1994 *Standards for the Data Collection from Human Skeletal Remains*. Arkansas Archaeological Survey Research Series, No. 44.
- Carr, G C & Knüsel, C 1997 'The ritual framework of excarnation by exposure as the mortuary practice of the early and middle Iron Ages of central southern Britain', in Gwilt, A & Haselgrove, C (eds) *Reconstructing Iron Age Societies*, 167–73. Oxbow Monograph 71. Oxford: Oxbow.
- Chenery, C, Muldner, G, Evans, J, Eckardt, H & Lewis, M 2010 'Strontium and stable isotope evidence for diet and mobility in Roman Gloucester, UK', *Journal of Archaeological Science* 37(1): 150–63.
- Child, A M 1995 'Microbial taphonomy of archaeological bone', *Studies in Conservation*

- 40(1): 19–30.
- Chisholm, B S, Nelson, D E, & Schwarcz, H P, 1982 'Stable carbon isotope ratios as a measure of marine versus terrestrial protein in ancient diets', *Science* 216: 1131–2.
- Clarke, D L 1970 *Beaker Pottery of Britain and Ireland*. Cambridge: Cambridge University Press.
- Clarke, D V, Cowie, T G & Foxton, A 1985 *Symbols of Power at the Time of Stonehenge*. Edinburgh: HMSO.
- Close-Brooks, J 1995 'Excavation of a cairn at Cnip, Uig, Isle of Lewis', *Proc Soc Antiq Scot* 125: 253–77.
- Coles, J M 1969 'Scottish Early Bronze Age metalwork', *Proc Soc Antiq Scot* 101: 1–110.
- Cook, M 2000 'An Early Bronze Age multiple burial cist from Mill Road Industrial Estate, Linlithgow, West Lothian', *Proc Soc Antiq Scot* 130: 77–91.
- Cowie, T 1995 'The pottery vessel', in Dunwell et al 1995a: 284–6.
- Crawford, I A 1977 'A corbelled bronze-age burial chamber and beaker evidence from the Rosinish machair, Benbecula', *Proc Soc Antiq Scot* 108: 94–107.
- Daux, V, Lecuyer, C, Heran, M A, Amiot, R, Simon, L, Fourel, F, Martineau, F, Lynnerup, N, Reychler, H & Escarguel, G 2008 'Oxygen isotope fractionation between human phosphate and water revisited', *Journal of Human Evolution* 55(6): 1138–47.
- Dunwell, A J, Neighbour, T & Cowie, T G 1995a 'A cist burial adjacent to the Bronze Age cairn at Cnip, Uig, Isle of Lewis', *Proc Soc Antiq Scot* 125: 279–88.
- Dunwell, A J, Cowie, T G, Bruce, M F, Neighbour, T & Rees, A R 1995b 'A Viking Age cemetery at Cnip, Uig, Isle of Lewis', *Proc Soc Antiq Scot* 125: 719–52.
- Einarsson, S, Josefsson, B & Lagerkvist, S 1983 'Determination of amino-acids with 9-fluorenylmethyl chloroformate and reversed-phase high-performance liquid-chromatography', *Journal of Chromatography* 282: 609–18.
- Evershed, R P & Tuross, N 1996 'Proteinaceous material from potsherds and associated soils', *Journal of Archaeological Science* 23: 429–36.
- Fitzpatrick, A P 2011 *The Amesbury Archer and the Boscombe Bowmen: Bell Beaker Burials on Boscombe Down, Amesbury, Wiltshire*. Wessex Archaeology Report 27. Oxford: Oxbow.
- French, C 1994 *Excavation of the Deeping St Nicholas Barrow Complex, South Lincolnshire*. Lincolnshire Archaeology & Heritage Report Series No. 1. Lincolnshire: Heritage Trust of Lincolnshire.
- Gibson, A M 2012 'Report on the excavation at Duggleby Howe causewayed enclosure, North Yorkshire', *Archaeological Journal* 168: 1–63.
- Gibson, W J 1934 'Some prehistoric relics from Lewis', *Proc Soc Antiq Scot* 68: 428–32.
- Gourlay, R 1984 'A short cist beaker inhumation from Chealamy, Strathnaver, Sutherland', *Proc Soc Antiq Scot* 114: 567–71.
- Greenwell, W 1865 'Notices of the examination of grave-hills in the North Riding of Yorkshire', *Archaeological Journal* 22: 97–117, 241–63.
- Greenwell, W & Rolleston, G 1877 *British Barrows*. Oxford.
- Grinsell, L V 1957 *A History of Wiltshire, Vol 1, Part 1*. London: Oxford University Press.
- Guarino, F M, Angelini, F, Vollono, C & Orefice, C 2006 'Bone preservation in human remains from the Terme del Sarno at Pompeii using light microscopy and scanning electron microscopy', *Journal of Archaeological Science* 33: 513–20.
- Hackett, C J 1981 'Microscopical focal destruction (tunnels) in exhumed human bones', *Medicine, Science and the Law* 21(4): 243–66.
- Hanson, M & Cain, C R 2007 'Examining histology to identify burned bone', *Journal of Archaeological Science* 34: 1902–13.
- Harding, D W 2000 'The Hebridean Iron Age: Twenty years' research'. Edinburgh: University of Edinburgh Department of Archaeology, Occasional Paper Series No. 20.
- Harding, D W & Dixon, T N 2000 *Dun Bharabhat, Cnip: An Iron Age Settlement in West Lewis, Vol 1: Structures and Material Culture*. University of Edinburgh Department of Archaeology, Calanais Research Series No. 2. Edinburgh.
- Harding, D W & Gilmour, S M D 2000 *The Iron Age Settlement at Beirgh, Riof, Isle of Lewis: Excavations 1985–95, Vol 1: The Structures and Stratigraphy*. University of Edinburgh Department of Archaeology, Calanais Research

- Series No. 1. Edinburgh.
- Harding, J & Healy, F 2007 *The Raunds Area Project: A Neolithic and Bronze Age Landscape in Northamptonshire*. Swindon: English Heritage.
- Harman, M 1984 'The skeletal remains', in Gourlay 1984: 570–1.
- Harris, O, Richardson, P, Cobb, H, Murtagh, P & Pringle, I 2011 'Chadh Andreis Chambered Cairn, Swordle Bay, Ardnamurchan. Season Five, 2010: Archaeological Excavations Data Structure Report'. Unpublished report.
- Hasan, H 2010 'Development of an LC-MS/MS method for the analysis of triacylglycerols from meat and application in the discrimination of cooked meat products', unpublished PhD thesis, University of York.
- Haynes, P A, Sheumack, D, Kibby, J & Redmond, J W 1991 'Amino-acid-analysis using derivatization with 9-fluorenylmethyl chloroformate and reversed-phase high-performance liquid-chromatography', *Journal of Chromatography* 540: 177–85.
- Healy, F & Harding, J 2004 'Reading a burial: the legacy of Overton Hill', in Gibson, A J S & Sheridan, A (eds) *From Sickles to Circles: Britain and Ireland at the time of Stonehenge*, 176–93. Stroud: Tempus.
- Hedges, R E M, Millard, A R & Pike, A W G 1995 'Measurements and relationships of diagenetic alteration of bone from three archaeological sites', *Journal of Archaeological Science* 22: 201–9.
- Hjulstrom, B & Isaksson, S 2009 'Identification of activity area signatures in a reconstructed Iron Age house by combining element and lipid analyses of sediments', *Journal of Archaeological Science* 36: 174–83.
- Hoare, R C 1812 *The Ancient History of South Wiltshire*. London.
- Jans, M M E 2008 'Microbial bioerosion of bone – a review', in Wisshak, M & Tapanila, L (eds) *Current Developments in Bioerosion*, 397–413. Berlin: Springer-Verlag.
- Jans, M M E, Nielsen-Marsh, C M, Smith, C I, Collins, M J & Kars, H 2004 'Characterisation of microbial attack on archaeological bone', *Journal of Archaeological Science* 31: 87–95.
- Jay, M & Richards, M P 2006 'Diet in the Iron Age cemetery population at Wetwang Slack, East Yorkshire, UK: Carbon and nitrogen stable isotope evidence', *Journal of Archaeological Science* 33(5): 653–62.
- Kerley, E R 1965 'The microscopic determination of age in human bone', *American Journal of Physical Anthropology* 23: 149–64.
- Kinnes, I 1979 'Round barrows and ring-ditches in the British Neolithic'. British Museum Occasional Paper 7. London.
- Kinnes, I & Longworth, H 1985 *Catalogue of the Excavated Prehistoric and Romano-British Material in the Greenwell Collection*. London: British Museum Publications.
- Kinnes, I A, Schadla-Hall, T, Chadwick, P & Dean, P 1983 'Duggleby Howe reconsidered', *Archaeological Journal* 140: 83–108.
- Knott, C 2010 'Cnip Headland, Uig, Isle of Lewis, Human Remains Call-Off Contract'. CK Archaeology Unpublished Data Structure Report.
- Krouse, H R & Herbert, M K 1988 'Sulphur and carbon isotope studies of food webs', in Kennedy, B V & LeMoine, G M (eds) *Diet and Subsistence: Current Archaeological Perspectives*, 315–22. Calgary: University of Calgary Archaeological Association.
- Lelong, O 2009 'Cnip Headland, Uig, Isle of Lewis, Human Remains Call-Off Contract'. GUARD Unpublished Data Structure Report 2803.
- Lovejoy, C O, Meindl, R S, Pryzbeck, T R & Mensforth, R P 1985 'Chronological metamorphosis of the auricular surface of the ilium: a new method for the determination of adult skeletal age at death', *American Journal of Physical Anthropology* 68:15–28.
- Mackie, R I, Sghir, A & Gaskins, H R 1999 'Developmental microbial ecology of the neonatal gastrointestinal tract', *American Journal of Clinical Nutrition* 69: 1035S–1045S.
- McLaren, D forthcoming 'A note on the provision of amulets and heirlooms in Earlier Bronze Age children's burials in Scotland'.
- Mant, A K 1987 'Knowledge acquired from post-war exhumations', in Boddington, A, Garland, A N & Janaway, R C (eds) *Death, Decay, and Reconstruction*, 65–80. Manchester: Manchester University Press.
- Masters, P M 1987 'Preferential preservation of non-collagenous protein during bone diagenesis: implications for chronometric and stable isotope

- measurements', *Geochimica et Cosmochimica Acta* 51: 3209–14.
- Maxwell, J H 1949 'Bronze Age graves at Patrickholm Sand Quarry, Larkhall, Lanarkshire excavated during the autumn of 1947', *Proc Soc Antiq Scot* 83: 207–20.
- Mays, S 1998 *The Archaeology of Human Bones*. London: Routledge.
- Mays, S, Brickley, M & Dodwell, N 2002 *Human Bones from Archaeological Sites: Guidelines for Producing Assessment Documents and Analytical Reports*. London: Centre for Archaeology Guidelines English Heritage/BABAO.
- Meindl, R S & Lovejoy, C O 1985 'Ectocranial suture closure: a revised method for the determination of skeletal age at death based on the lateral-anterior sutures', *American Journal of Physical Anthropology* 68: 57–66.
- Molleson, T & Cox, M 1993 *The Spitalfields Project, Vol 2: The Anthropology. The Middling Sort*. York: Council for British Archaeology.
- Montgomery, J, Evans, J A & Neighbour, T 2003 'Sr isotope evidence for population movement within the Hebridean Norse community of NW Scotland', *Journal of the Geological Society* 160: 649–53.
- Mook, W G 1986 'Business meeting: Recommendations/Resolutions adopted by the Twelfth International Radiocarbon Conference', *Radiocarbon* 28: 799.
- Mottram, H R, Woodbury, S E & Evershed, R P 1997 'Identification of triacylglycerol positional isomers present in vegetable oils by high performance liquid chromatography/atmospheric pressure chemical ionization mass spectrometry', *Rapid Communications in Mass Spectrometry* 11: 1240–52.
- Nielsen-Marsh, C M, Smith, C I, Jans, M M E, Nord, A, Kars, H & Collins, M J 2007 'Bone diagenesis in the European Holocene II: taphonomic and environmental considerations', *Journal of Archaeological Science* 34(9): 1523–31.
- Noakes, J E, Kim, S M & Stipp, J J 1965 'Chemical and counting advances in Liquid Scintillation Age dating', in Olsson, E A & Chatter, R M (eds) *Proceedings of the Sixth International Conference on Radiocarbon and Tritium Dating*, 68–92. Pullman: Washington State University Press.
- O'Neil, J R, Roe, L J, Reinhard, L & Blake, R E 1994 'A rapid and precise method of oxygen isotope analysis of biogenic phosphate', *Israel Journal of Earth Science* 43: 203–12.
- Ortner, D J 2003 *Identification of Pathological Conditions in Human Skeletal Remains*. London: Academic Press.
- Parker Pearson, M, Sharples, N & Symonds, J 2004 *South Uist: Archaeology and History of a Hebridean Island*. Stroud: Tempus.
- Parker Pearson, M, Chamberlain, A, Craig, O, Marshall, P, Mulville, J, Smith, H, Chenery, C, Collins, M, Cook, G, Craig, G, Evans, J, Hiller, J, Montgomery, J, Schwenninger, J L, Taylor, G & Weiss, T 2005 'Evidence for mummification in Bronze Age Britain', *Antiquity* 79: 529–46.
- Parker Pearson, M, Chamberlain, A, Craig, O, Marshall, P, Mulville, J, Smith, H, Chenery, C, Collins, M, Cook, G, Craig, G, Evans, J, Hiller, J, Montgomery, J, Schwenninger, J L, Taylor, G & Weiss, T 2007 'Further evidence for mummification in Bronze Age Britain', *Antiquity* 81: 313.
- Piggott, S 1938 'The early bronze age in Wessex', *Proceedings of the Prehistoric Society* 4: 52–106.
- Piggott, S 1962 'From Salisbury Plain to Siberia', *Wiltshire Archaeological and Natural History Magazine* 58: 93–7.
- Privat, K L, O'Connell, T C & Hedges, R E M 2007 'The distinction between freshwater- and terrestrial-based diets: Methodological concerns and archaeological applications of sulphur stable isotope analysis', *Journal of Archaeological Science* 34(8): 1197–204.
- Puglisi, E, Nicelli, M, Capri, E, Trevisan, M & Del Re, A A M 2003 'Cholesterol, beta-sitosterol, ergosterol, and coprostanol in agricultural soils', *Journal of Environmental Quality* 32: 466–71.
- Redfern, R 2008 'New evidence for Iron Age secondary burial practice and bone modification from Gussage All Saints and Maiden Castle (Dorset, England)', *Oxford Journal of Archaeology* 27(3): 281–301.
- Reimer, P J, Baillie, M G L, Bard, E, Bayliss, A, Beck, J W, Blackwell, P G, Bronk Ramsey, C, Buck, C E, Burr, G S, Edwards, R L, Friedrich, M, Grootes, P M, Guilderson, T P, Hajdas, I, Heaton, T J, Hogg, A G, Hughen, K A, Kaiser, K F, Kromer, B, McCormac, F G, Manning, S W, Reimer, R W, Richards, D A, Southon, J

- R, Talamo, S, Turney, C S M, van der Plicht, J & Weyhenmeyer, C E 2009 'IntCal09 and Marine09 radiocarbon age calibration curves, 0–50,000 years cal BP', *Radiocarbon* 51(4): 1111–50.
- Renfrew, A C 1974 'Beyond a subsistence economy: The evolution of prehistoric Europe', in Moore, C B (ed.), *Reconstructing Complex Societies*, 69–95. Bulletin of the American Schools of Oriental Research 20. Cambridge, MA.
- Richards, M P, Fuller, B T & Hedges, R E M 2001 'Sulphur isotopic variation in ancient bone collagen from Europe: Implications for human palaeodiet, residence mobility, and modern pollutant studies', *Earth and Planetary Science Letters* 191(3–4): 185–90.
- Richards, M P, Fuller, B T, Sponheimer, M, Robinson, T & Ayliffe, L 2003 'Sulphur isotopes in palaeodietary studies: A review and results from a controlled feeding experiment', *International Journal of Osteoarchaeology* 13: 37–45.
- Richards, M P, Fuller, B T & Molleson, T I 2006 'Stable isotope palaeodietary study of humans and fauna from the multi-period (Iron Age, Viking and Late Medieval) site of Newark Bay, Orkney', *Journal of Archaeological Science* 33(1): 122–31.
- Roberts, C & Manchester, K 1999 *The Archaeology of Disease*, 2nd edition. Somerset: Sutton Publishing.
- Rogers, A 2013 *Female Burial Traditions of the Chalcolithic and Early Bronze Age: A Pilot Study Based on Modern Excavations*. Oxford: British Archaeological Reports, British Series, 581.
- Scheuer, L & Black, S 2000 *Developmental Juvenile Osteology*. London: Academic Press.
- Scheuer, L & Black, S 2004 *The Juvenile Skeleton*. London: Elsevier Academic Press.
- Schoeninger, M J, Deniro, M J & Tauber, H 1983 'Stable nitrogen isotope ratios of bone collagen reflect marine and terrestrial components of prehistoric diets', *Science* 216: 1381–3.
- Scott, E M 2003 'The Third International Radiocarbon Intercomparison (TIRI) and the Fourth International Radiocarbon Intercomparison (FIRI) 1990–2002: results, analysis, and conclusions', *Radiocarbon* 45(2): 135–408.
- Sharples, N M & Sheridan, J A 2012 'Copper alloy awl', in Parker Pearson, M (ed.) *From Machair to Mountains: Archaeological Survey and Excavation in South Uist*, 236. Oxford and Oakville CT: Oxbow Books.
- Shennan, S 1982 'Ideology, Change and the European Early Bronze Age', in Hodder, I (ed.) *Symbolic and Structural Archaeology*, 155–61. Cambridge: Cambridge University Press.
- Sheridan, J A 2003 'Supernatural power dressing', in *British Archaeology* 70: 18–23.
- Sheridan, J A 2004 'Scottish Food Vessel chronology revisited', in Gibson, A J S & Sheridan, J A (eds) *From Sickles to Circles: Britain and Ireland at the Time of Stonehenge*, 243–67. Stroud: Tempus.
- Sheridan, J A 2008a 'Upper Largie and Dutch-Scottish connections during the Beaker period', in Fokkens, H, Coles, B J, van Gijn, A L, Kleijne, J P, Ponjee, H H & Slappendel, C G (eds) *Between Foraging and Farming: An Extended Broad Spectrum of Papers Presented to Leendert Louwe Kooijmans*, 247–60. *Analecta Praehistorica Leidensia* 40. Leiden: Leiden University.
- Sheridan, J A 2008b 'Towards a fuller, more nuanced narrative of Chalcolithic and Early Bronze Age Britain 2500–1500 BC', *Bronze Age Review* 1: 57–78.
- Sheridan, J A 2012a 'Pottery', in Parker Pearson, M (ed.) *From Machair to Mountains: Archaeological Survey and Excavation in South Uist*, 227–36. Oxford and Oakville CT: Oxbow Books.
- Sheridan, J A 2012b 'Contextualising Kilmartin: building a narrative for developments in western Scotland and beyond, from the Early Neolithic to the Late Bronze Age', in Jones, A M, Pollard, J, Allen, M J & Gardiner, J P (eds) *Image, Memory and Monumentality: Archaeological Engagements with the Material World*, 163–83. Prehistoric Society Research Paper 5. Oxford: Oxbow Books and the Prehistoric Society.
- Sheridan, J A 2013 'Chalcolithic (Copper Age) and Bronze Age Bute, c 2500–c 800 BC: an assessment', in Duffy, P R J (ed.) *One Island, Many Voices: Bute, Archaeology and the Discover Bute Landscape Partnership Scheme*, 53–71. Donington: Shaun Tyas.
- Sheridan, J A & Bradley, R J 2007 'Radiocarbon dates arranged through National Museums Scotland during 2006/7', *Discovery and*

- Excavation in Scotland* 8: 220–1.
- Sheridan, J A & Davis, M 2002 'Investigating jet and jet-like artefacts from prehistoric Scotland: The National Museums of Scotland project', *Antiquity* 76: 812–25.
- Sheridan, J A, Schulting, R J & Wright, J 2006 'The National Museums of Scotland radiocarbon dating programmes: Results obtained during 2005/6', *Discovery and Excavation in Scotland* 7: 204–6.
- Sheridan, A, Needham, S, O'Connor, S, Melton, N, Janaway, R, Cameron, E & Evans, A 2013 'The Gristhorpe coffin and its contents', in Melton, N D, Montgomery, J & Knüsel, C J (eds) *Gristhorpe Man: A Life and Death in the Bronze Age*, 148–65. Oxford and Oakville CT: Oxbow Books.
- Simmons, T, Cross, P A, Adlam, R E & Moffatt, C 2010 'The influence of insects on decomposition rate in buried and surface remains', *Journal of Forensic Sciences* 55(4): 889–92.
- Simpson, D D A 1968 'Food Vessels: associations and chronology', in Coles, J M & Simpson, D D A (eds) *Studies in Ancient Europe: Essays Presented to Stuart Piggott*, 197–211. Leicester: Leicester University Press.
- Slota Jr, P J, Jull, A J T, Linick, T W & Toolin, L J 1987 'Preparation of small samples for ^{14}C accelerator targets by catalytic reduction of CO ', *Radiocarbon* 29(2): 303–6.
- Smith, C 2012 'The bird bone', in Johnson, M & Cameron, K 'An Early Bronze Age unenclosed cremation cemetery and Mesolithic pit at Skilmafilly, near Maud, Aberdeenshire', *Scottish Archaeological Internet Reports*, 53: 30–1. <https://doi.org/10.9750/issn.1773-3808.2012.53>.
- Smith, C I, Nielsen-Marsh, C M, Jans, M M E, Arthur, P, Nord, A G & Collins, M J 2002 'The strange case of Apigliano: Early "fossilisation" of medieval bone in southern Italy', *Archaeometry* 44(3): 405–15.
- Smith, C I, Nielsen-Marsh, C M, Jans, M M E & Collins, M J 2007 'Diagenesis in the European Holocene I: Patterns and mechanisms', *Journal of Archaeological Science* 34(9): 1485–93.
- Smith, C N S 1957 'A catalogue of the prehistoric finds from Worcestershire', *Transactions of the Worcestershire Archaeological Society, New Series* 34: 1–27.
- Steier, P & Rom, W 2000 'The use of Bayesian statistics for ^{14}C dates of chronologically ordered samples: a critical analysis', *Radiocarbon* 42: 183–98.
- Stenhouse, M J & Baxter, M S 1983 ' ^{14}C reproducibility: evidence from routine dating of archaeological samples', *Proceedings of the First International Symposium 14C and Archaeology (PACT)* 8: 147–61.
- Stevenson, R B K 1939 'Jet necklace from a cist in Strathnaver', *Proc Soc Antiq Scot* 73: 325–6.
- Stuiver, M & Kra, R S 1986 'Editorial comment', *Radiocarbon* 28(2B): ii.
- Stuiver, M & Polach, H A 1977 'Reporting of ^{14}C data', *Radiocarbon* 19(3): 355–63.
- Stuiver, M & Reimer, P J 1986 'A computer program from radiocarbon age calibration', *Radiocarbon* 28: 1022–30.
- Stuiver, M & Reimer, P J 1993 'Extended ^{14}C data base and revised CALIB 3.0 ^{14}C calibration program', *Radiocarbon* 35(1): 215–30.
- Tannock, G W 1995 *Normal Microflora: An Introduction to Microbes Inhabiting the Human Body*. London: Chapman & Hall.
- Thomas, J 1999 *Understanding the Neolithic*. London: Routledge.
- Thomas, N 1968 'Note on the Carrickinab awl', in Collins, A E P & Evans, E E (eds) 'A cist burial at Carrickinab, Co. Down', *Ulster Journal of Archaeology* 31: 16–24.
- Thomas, N 2005 'Early Bronze Age copper-alloy awls from Sites I and II, with metal analysis and classification', in Thomas, N (ed.) *Snail Down, Wiltshire. The Bronze Age Barrow Cemetery and Related Earthworks, in the Parishes of Collingbourne Ducis and Collingbourne Kingston: Excavations 1953, 1955 and 1957*, 219–22. Devizes: Wiltshire Archaeological and Natural History Society.
- Trotter, M 1970 'Estimation of stature from intact long limb bones', in Stewart, T D (ed.) *Personal Identification in Mass Disasters*, 71–83. Washington DC: Smithsonian Institute.
- Tuross, N, Fogel, M L & Hare, P E 1988 'Variability in the preservation of the isotopic composition of collagen from fossil bone', *Geochimica et Cosmochimica Acta* 52: 929–35.
- Ubelaker, D H 1989 *Human Skeletal Remains*. Washington: Taraxacum.
- van Gennep, A 1960 [1908] *The Rites of Passage*.

- Chicago: University of Chicago Press.
- Ward, G K & Wilson, S R 1978 'Procedures for comparing and combining radiocarbon age determinations: a critique', *Archaeometry* 20: 19–32.
- Watkins, T 1982 'The excavation of an Early Bronze Age cemetery at Barns Farm, Dalgety, Fife', *Proc Soc Antiq Scot* 112 (1982): 48–141.
- Wessex Archaeology 2008 *Allasdale Dunes, Barra, Western Isles, Scotland: Archaeological Evaluation and Assessment of Results*. Report 65305.01.
- White, L 2009 'The Microbiology of Death', unpublished PhD thesis, University of Sheffield.
- Woodward, A 2002 'Beads and Beakers: heirlooms and relics in the British Early Bronze Age', *Antiquity* 76: 1040–7.
- Woodward, A & Hunter, J 2015 *Ritual in Early Bronze Age Grave Goods: An Examination of Ritual and Dress Equipment from Chalcolithic and Early Bronze Age Graves in England*. Oxford and Philadelphia: Oxbow.
- Woodward, A, Hunter, J, Ixer, R, Maltby, M, Potts, P J, Webb, P C, Watson, J S & Jones, M C 2005 'Ritual in some Early Bronze Age gravegoods', *Archaeological Journal* 162: 31–64.
- Xu, S, Anderson, R, Bryant, C, Cook, G T, Dougans, A, Freeman, S, Naysmith, P, Schnabel, C & Scott, E M 2004 'Capabilities of the new SUERC 5MV AMS facility for ¹⁴C dating', *Radiocarbon* 46(1): 59–64.